

システム別配線図



電源(電源一負荷)

R/B NO.1 (右カウルサイド)

電 源	負 荷	ページ	
15A	テールランプ	テールランプリレー, クリアランスランプ, テールランプ, ライセンスプレートランプ	40
		ラジオ & ステレオ照明, A/Tインジケータランプ, トランスミッションインジケータ照明, ヒーターコントロール照明, パターンセレクトスイッチ照明, シガレットライター照明, ハザードスイッチ照明, 灰皿照明, コンビメータ照明, フォグランプスイッチ照明	42, 43
		ライトリマインダーリレー	45
		フォグランプリレー	52
		クロック	87
15A	ラジオ・ライター	ライトリマインダーリレー	45
		リモートコントロールアクチュエーター, ミラーコントロールリレー	58, 59
		シフトロックコントロールリレー	84
		シガレットライター, クロック	87
		ラジオ & ステレオ(CD又はDATなし), CDアンプ(CD又はDAT付き)	88, 89
		アンテナモーター	92
7.5A	メーター	クーリングファンウォーニングランプ	26
		チェックエンジンウォーニングランプ, 排気温ウォーニングランプ, ターボインジケータランプ(3S-GTE)	30, 34
		ライトリマインダーリレー	45
		ステアリング連動フォグコンピューター, ステアリングセンサー	52
		パワーステアリングドライバー, パワーステアリングコンピューター, ステアリングセンサー, パワーステアリングウォーニングランプ	61
		デフォッガースイッチ, デフォッガーリレー, ミラーヒーターヒューズ	64
		ドアコントロールリレー	66
		ドアコントロールリレー	69
		エンジンコントロールコンピューター, パワーインジケータランプ, O/D OFFインジケータランプ	72, 73
		ABSコンピューター, ABSウォーニングランプ	76
		A/Dインジケータランプ	81
		バッテリー液量レベルリレー, コンビネーションメーター	94, 95
		エアインレットサーボ, エアコンアンプ, ヒーターコントロール, モードコントロールサーボ, オートエアコンアンプ, ヒーターリレー	98, 99, 100, 101, 104
7.5A	ターン	ターンシグナルフラッシャー	46
20A	デフォッガー	リヤウインドウデフォッガー	64
20A	ワイパー	ウインドシールドワイパーリレー, ウォッシャーモーター, ワイパーモーター	56
10A	ストップランプ	エンジンコントロールコンピューター	29, 33
		ストップランプ, ハイマウントストップランプ	48
		エンジンコントロールコンピューター	72
		A/Dコンピューター	81
		シフトロックコントロールリレー	84
20A	ドアロック	ドアコントロールリレー	66
		ドアコントロールリレー	68
		ABSコンピューター	77
30A	パワーウインドウ	パワーウインドウモーター, ドアコントロールスイッチ	66
7.5A	ミラーヒーター	ミラーヒーター	64

R/B NO.2(エンジンルーム)

電 源		負 荷	ページ
7.5A	エレクトロニクスIG	オルタネーター	24
		クーリングファンコンピューター	26
		バックアップランプ, リバースウォーニングブザー	49
		トランスミッションインジケータランプ, エンジンコントロールコンピューター	73
		A/Dスピードセンサー, A/Dコンピューター	80
		シフトロックコントロールリレー	84
		アンテナモーター	92
20A	エンジンルームファン	クーリングファンモーター	26
15A	EFI	サーキットオープニングリレー, フューエルポンプ, ダイアグノーシスコネクター, O ₂ センサー(3S-GE), ISCロータリーバルブ, VSV(FPU)(3S-GE), VSV(T-VIS), エンジンコントロールコンピューター, フューエルポンプリレー(3S-GTE), フューエルポンプレジスター(3S-GTE), VSV(TPC)(3S-GTE)	28, 29, 32, 33
		エンジンコントロールコンピューター, ISCロータリーバルブ	72

R/B NO.5(フロントラゲージルーム)

15A	ルームランプ	半ドアウォーニングランプ, ルームランプ, ドアカーテシーランプ, ラゲージルームランプ, インテリアランプコントロールリレー	50
		ドアコントロールレシーバー	68
		クロック	87
		ラジオ & ステレオ(CD又はDATなし), CDアンプ(CD又はDAT付き), ウーハーアンプ	88, 90, 91
		アンテナモーター	92
30A	リトラ	リトラクターコントロールリレー	38
15A	ハザード・ホーン	ターンシグナルフラッシャー	46
		ホーンリレー, ホーン	86
7.5A	AM2	メインリレー(イグニッション), メインリレー(ファン)	18
		スターターリレー	21
		チャージウォーニングランプ	24
		クーリングファンリレー	26
		メインリレー(EFI), サーキットオープニングリレー, エンジンコントロールコンピューター	28, 29, 32, 33
		ラジエーターファンリレー, コンデンサーファンリレーNo.2	37, 97
		メインリレー(EFI), エンジンコントロールコンピューター	72
		A/Dコンピューター(A/T)	80
7.5A	エレクトロニクスB	ステアリング連動フォグコンピューター	53
		ミラーコントロールリレー	59
		ABSコンピューター	77
10A	エアコン	エアコンスイッチ, マグネットクラッチリレー, マグネットクラッチ, エアコンアンプ, VSV(エアコンアイドルアップ)	97, 98, 99, 100, 101
15A	ヘッドランプ(右)	ヘッドランプRH	38
15A	ヘッドランプ(左)	ヘッドランプLH	38
15A	フォグラмп	フォグラмп, ステアリング連動フォグコンピューター	52
30A	ラジエーターファン	ラジエーターファンモーター	37, 97
30A	コンデンサーファン	コンデンサーファンモーター	97
7.5A	オルタセンシング	オルタネーター	24



電源(電源一負荷)

電 源		負 荷	ページ
40A	FL AM2	EFIヒューズ, エレクトロニクスIGヒューズ, エンジンルームファンヒューズ	18
		コンデンサー(ラジオ), イグニッションコイル, イグナイター	22
		メインインジェクター(3S-GE), ソレノイドレジスター(3S-GTE)	28, 32
120A 100A (注1)	FLオルタ	FL ABS, FL AM1, FLヒーター, ラジエーターファンヒューズ, コンデンサーファンヒューズ	18
		オルタネーター	24
80A 60A (注2)	FL ABS	パワーステアリングドライバー, パワーステアリングモーター, パワーステアリングコンピューター	61
		ABSアクチュエーター, ABSコンピューター	76
40A	FLヒーター	エアコンヒューズ	18
		ブLOWERモーター	101, 104
50A	FL AM1	フォグランプヒューズ, テールランプヒューズ, デフォッガーヒューズ, ストップランプヒューズ, ドアロックヒューズ, パワーウインドウヒューズ, ワイパーヒューズ, メーターヒューズ, ターンヒューズ, ラジオ・ライターヒューズ	18, 19

ヒューズブルリンク(バッテリー横)

2.0L	FL	オルタセンシングヒューズ, FL AM2, FLオルタ, AM2ヒューズ, エレクトロニクスBヒューズ, ルームランプヒューズ, リトラヒューズ, ハザード・ホーンヒューズ, ヘッドランプリレー, ヘッドランプ(右)ヒューズ, ヘッドランプ(左)ヒューズ	18
1.0Y	FL	スターター	21

(注1) 120A:パワーステアリングなし 100A:パワーステアリング付き

(注2) 80A:パワーステアリングなし 60A:パワーステアリング付き

MEMO



電源

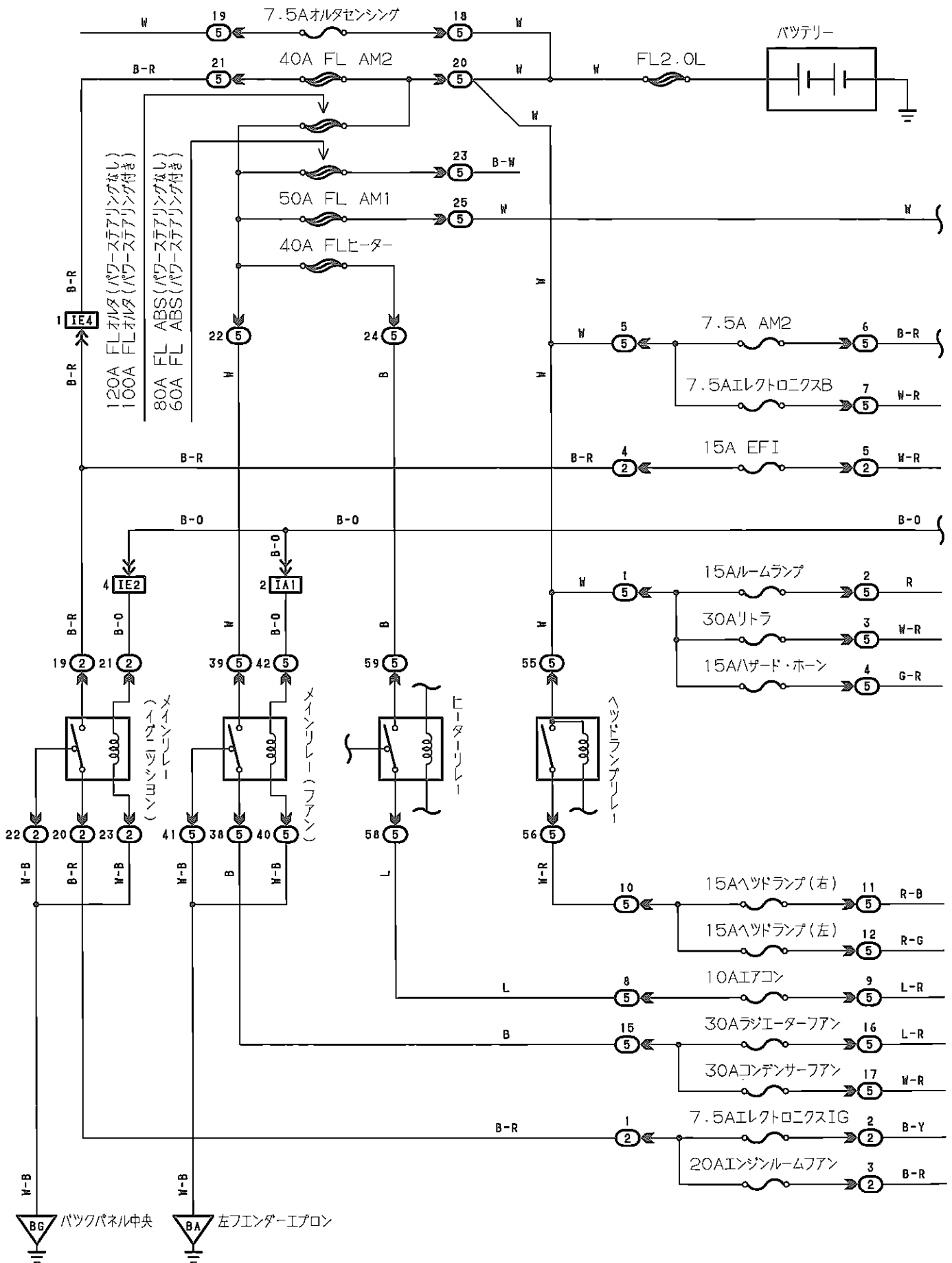

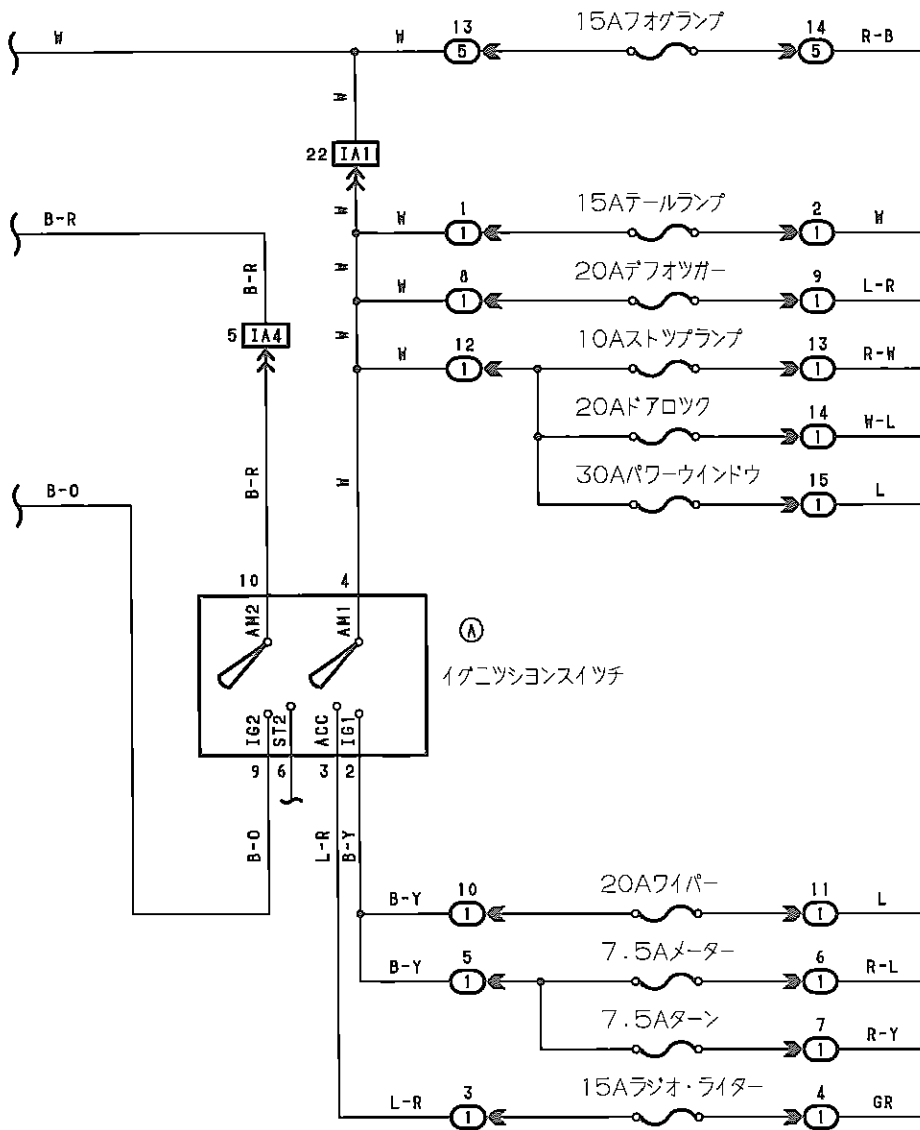



電源

Ⓐ 黑色

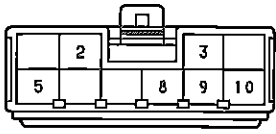

IA1

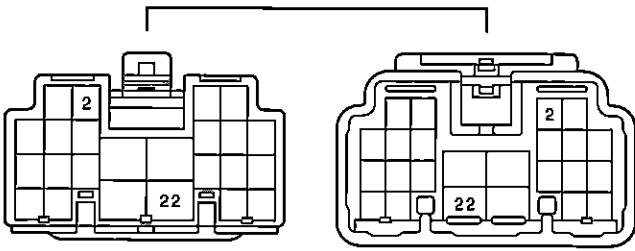

IA4

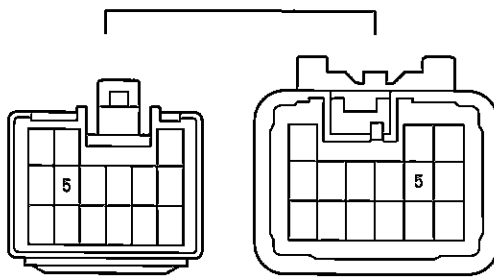

IE2

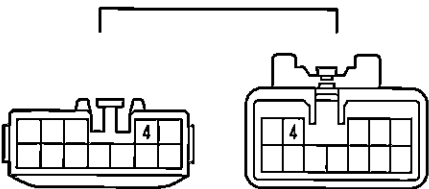

IE4

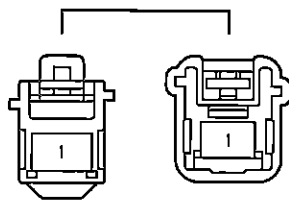

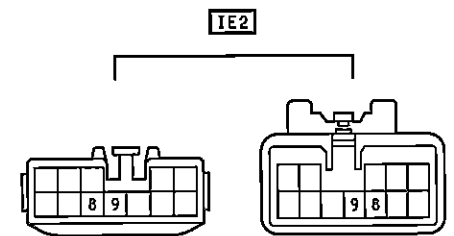
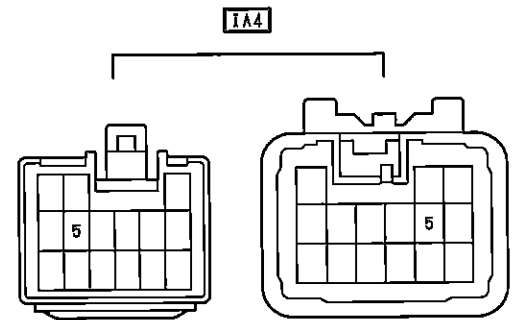
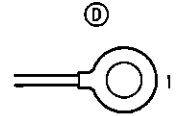
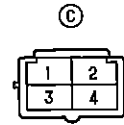
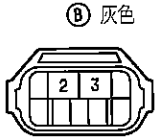
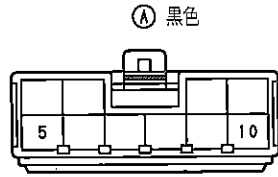
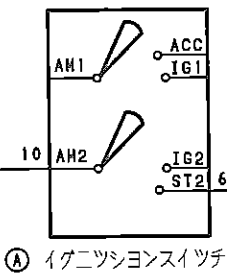
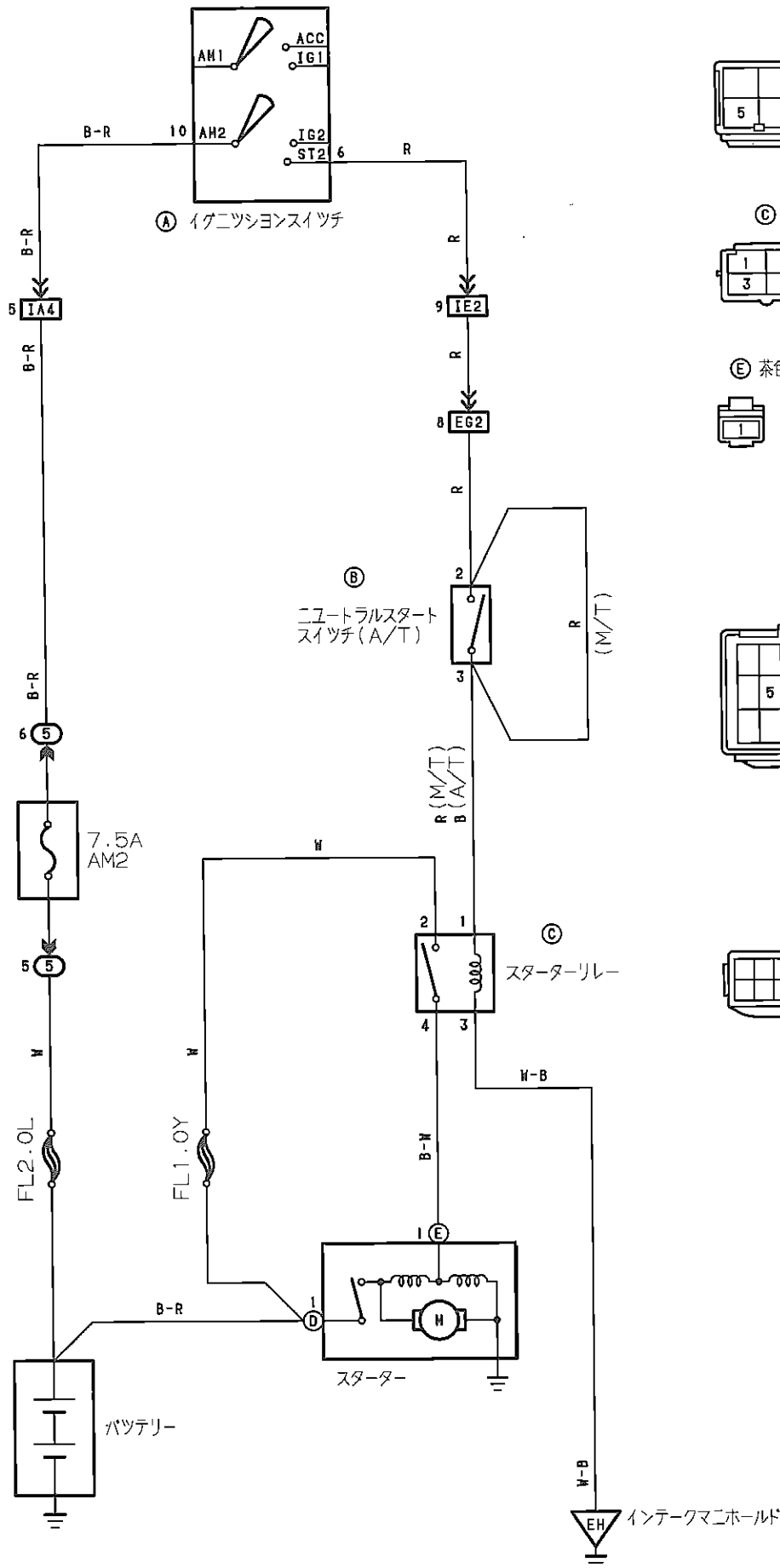



イグニツション

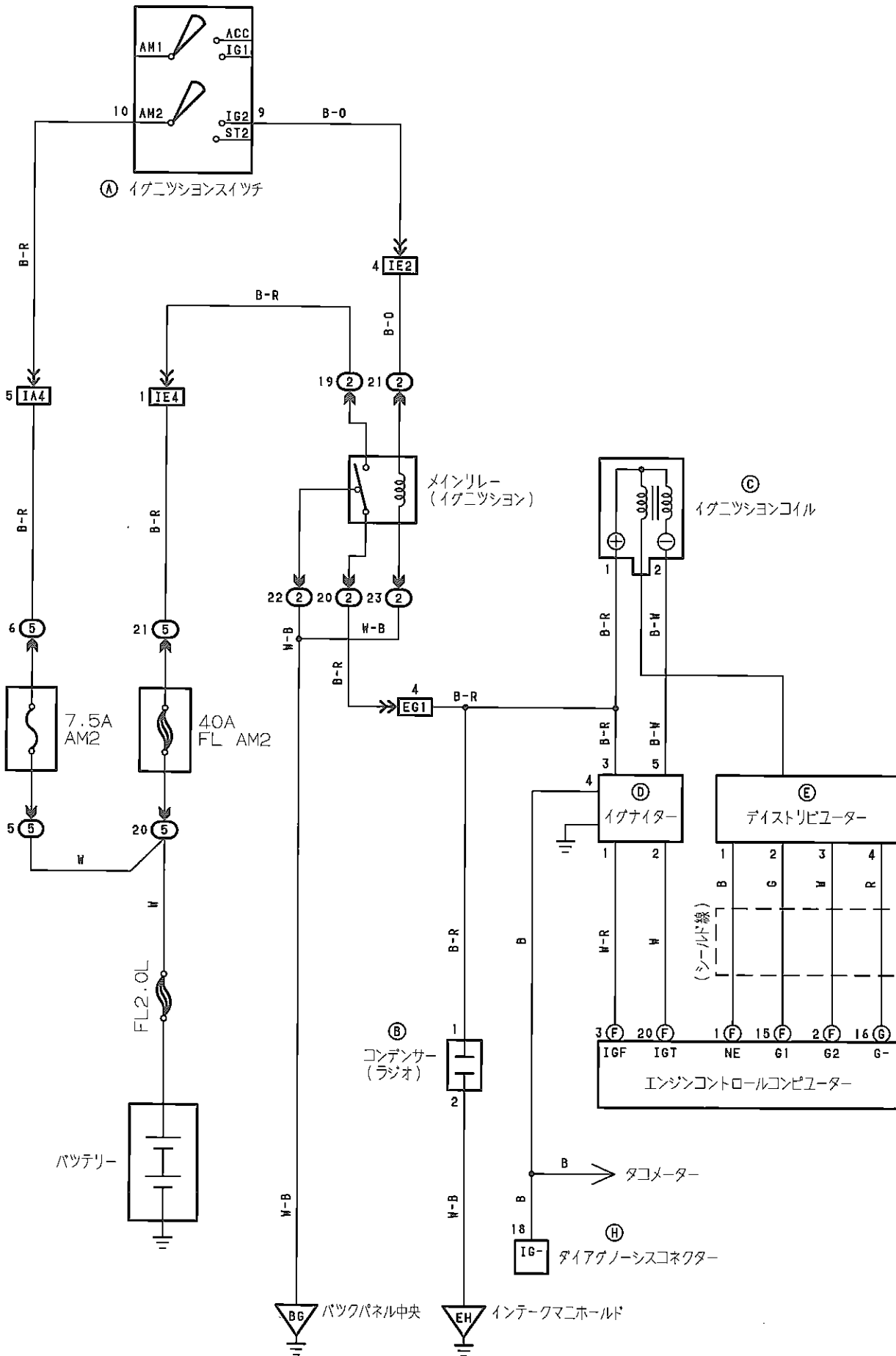

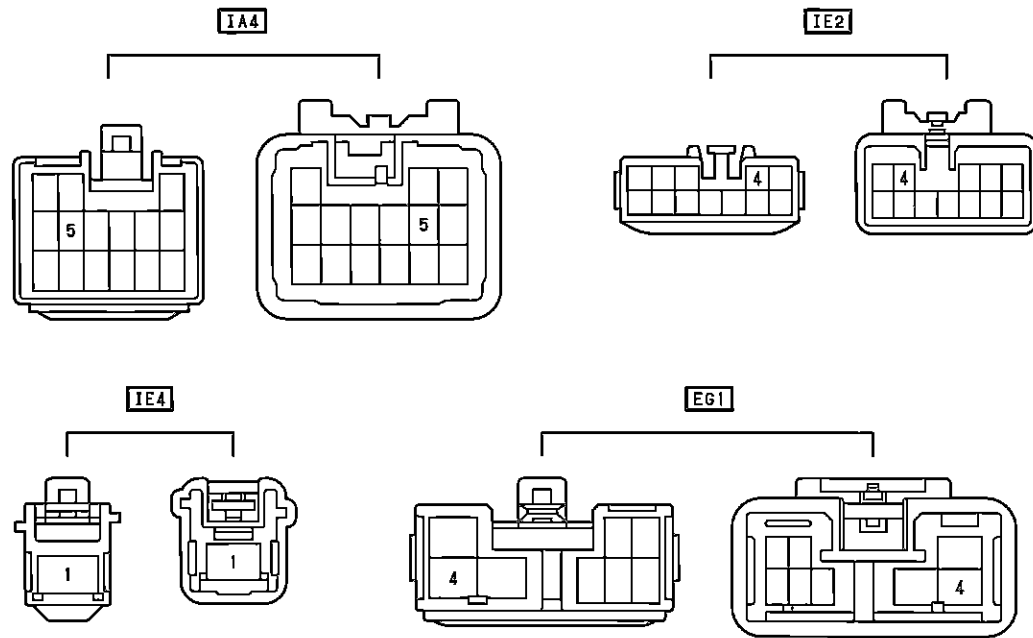
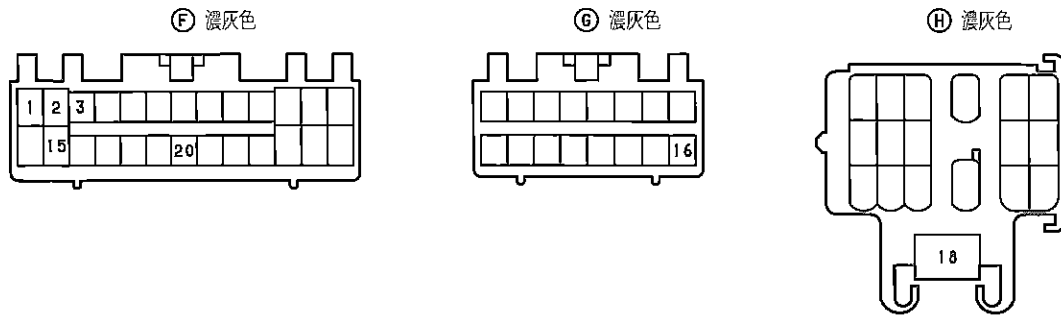
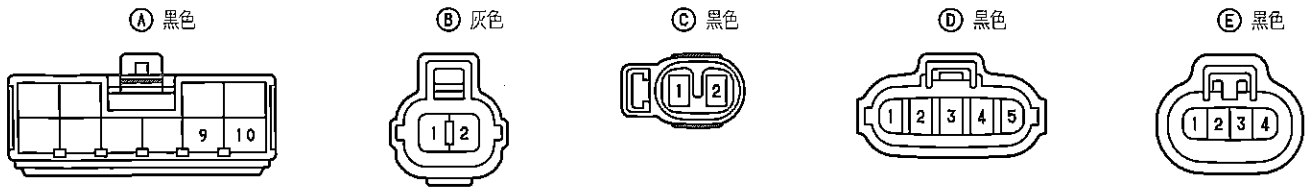



充電

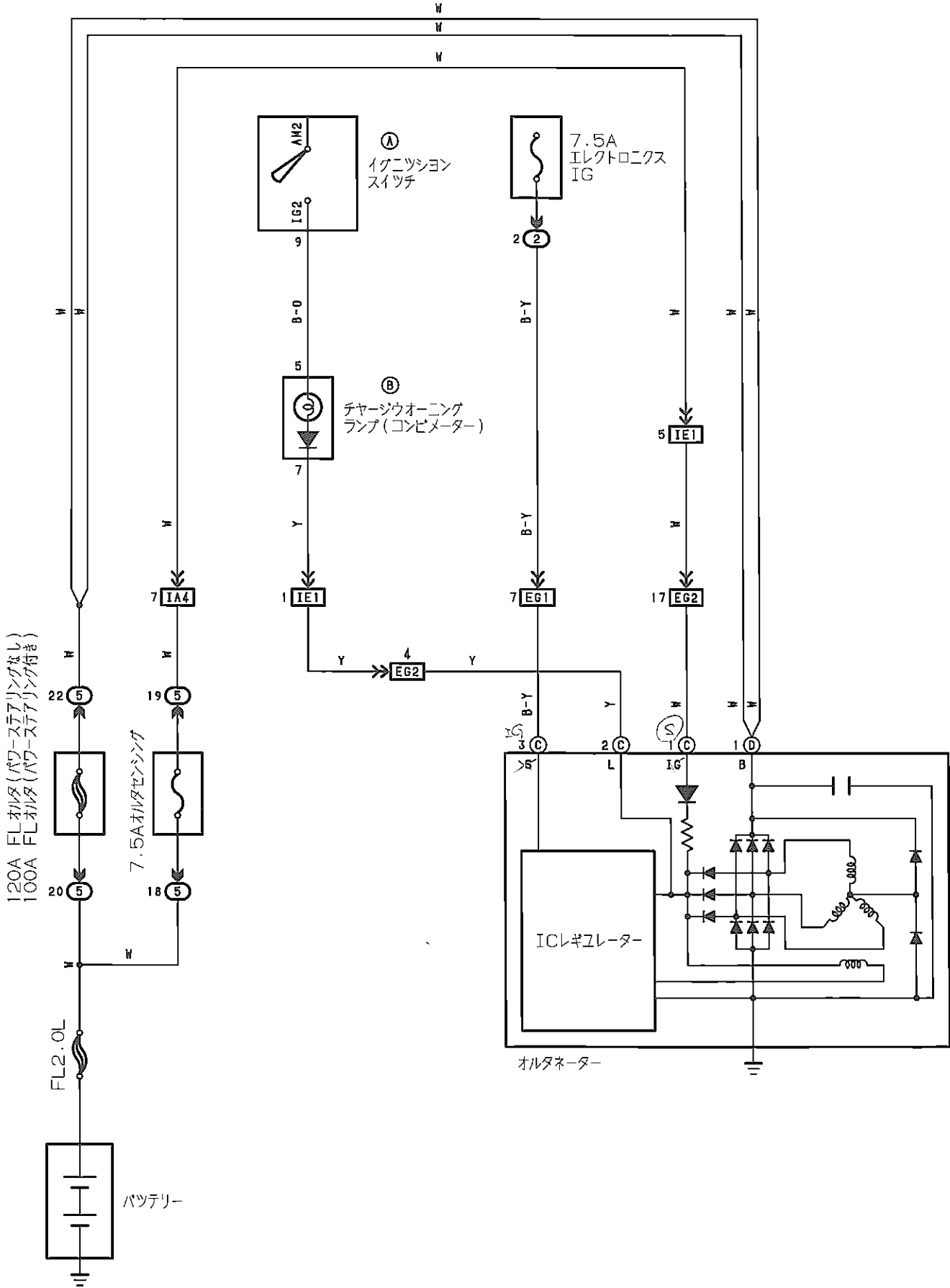

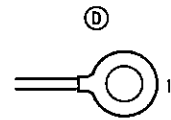
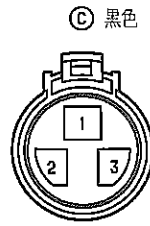
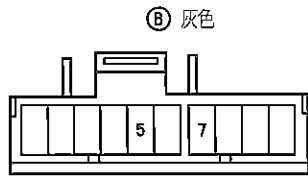
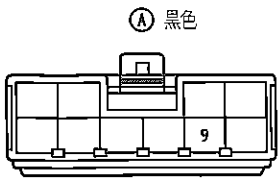

IE1 E62

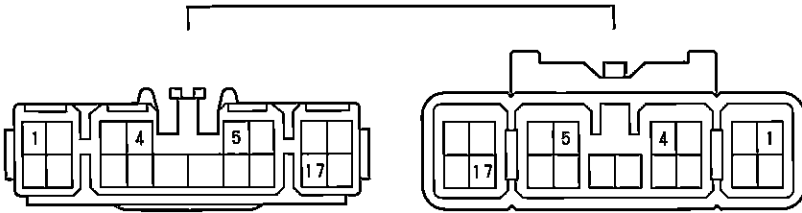

IA4

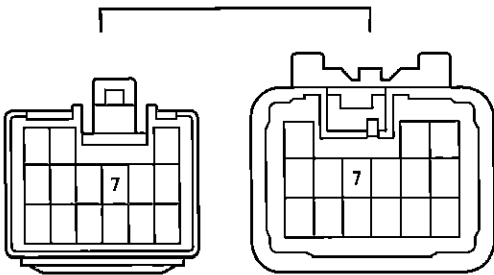

E61

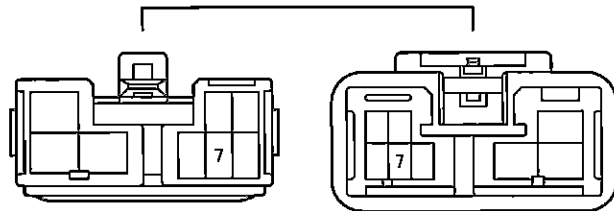



エンジンルームクーリングファン

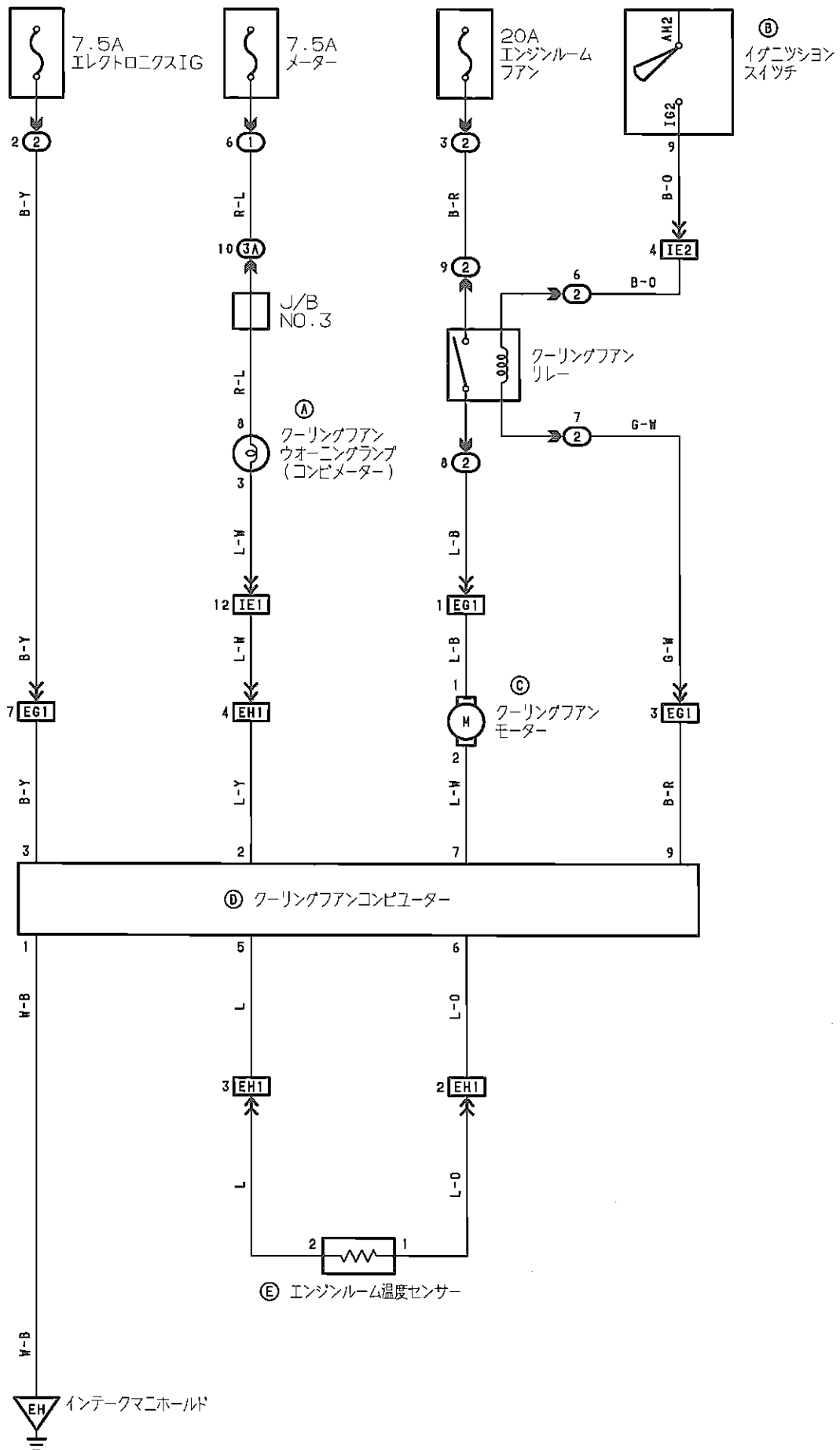

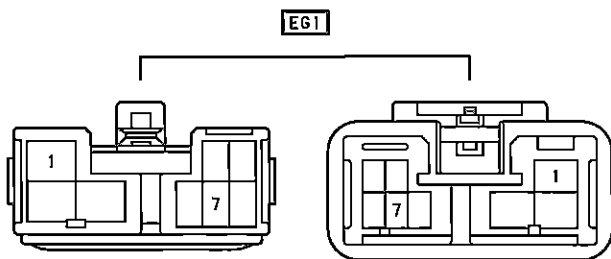
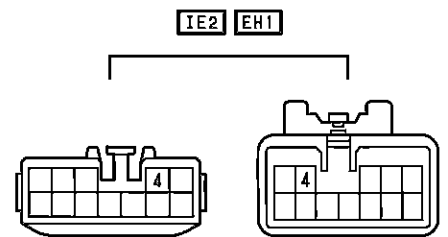
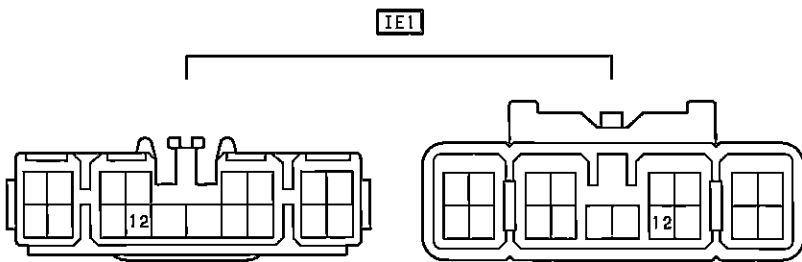
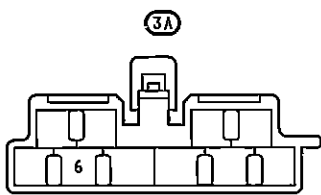
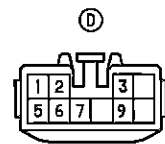
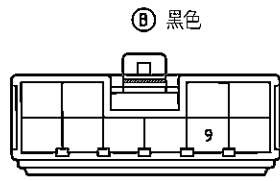
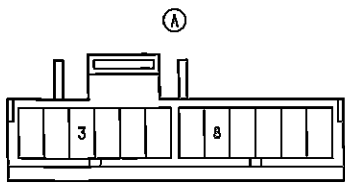

EFI (3S-GE)

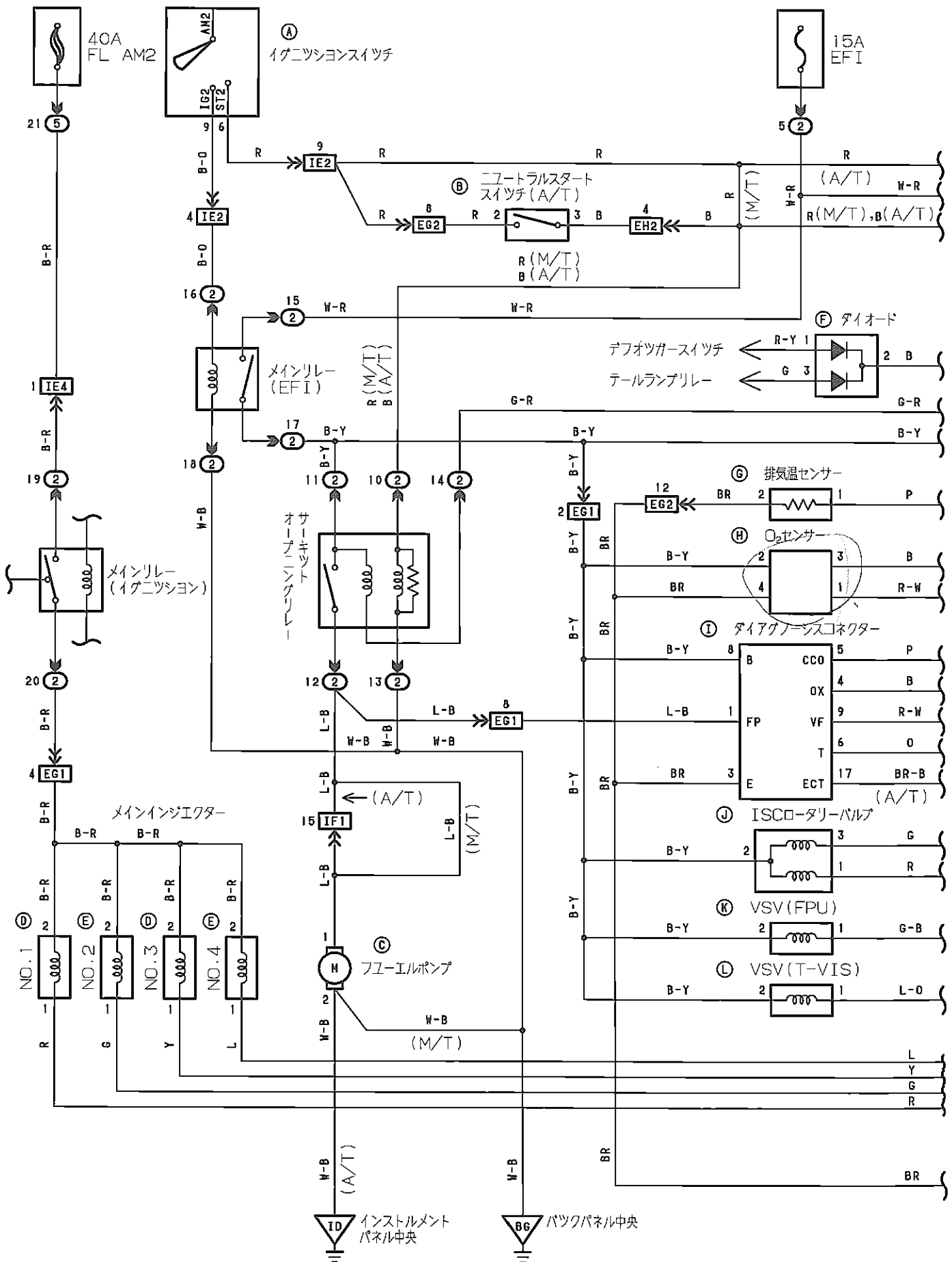

エンジンコントロールコンピューター

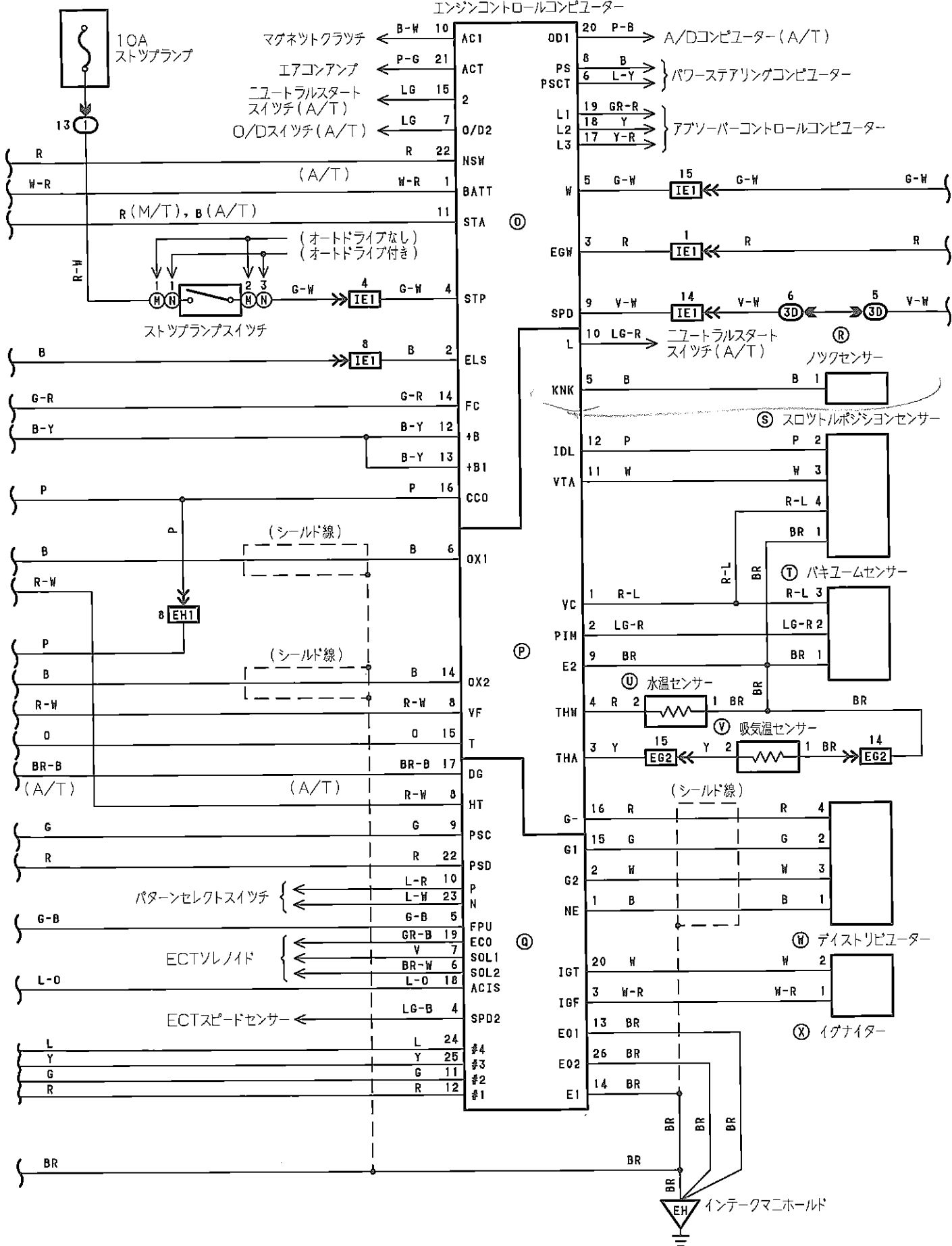



EFI (3S-GE)

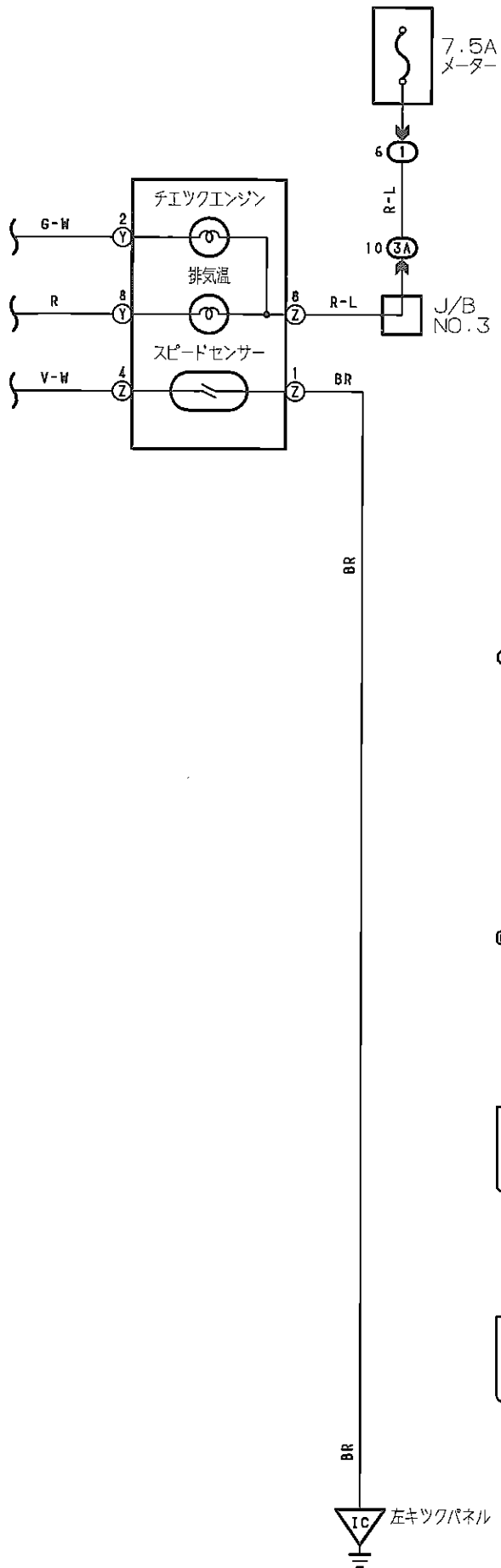

Ⓐ 黒色

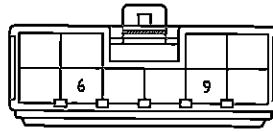

Ⓑ 灰色

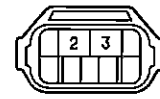

Ⓒ

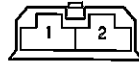

Ⓓ 茶色



Ⓔ 灰色



Ⓕ だいたい色

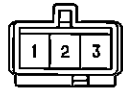

Ⓖ

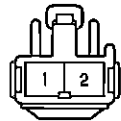

Ⓕ

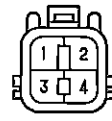

Ⓖ 濃灰色

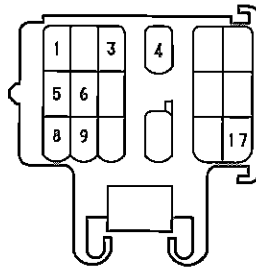

Ⓙ 灰色

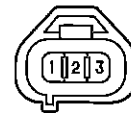

Ⓚ 青色



Ⓛ 緑色



Ⓜ 黒色



Ⓝ

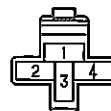

Ⓛ 濃灰色

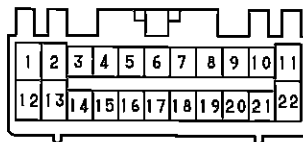

Ⓟ 濃灰色

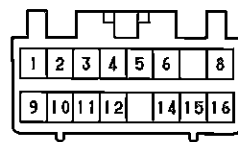

Ⓠ 濃灰色

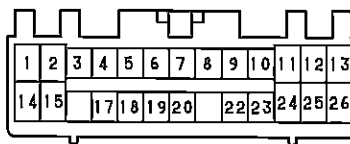

Ⓡ 濃灰色



Ⓢ 黒色



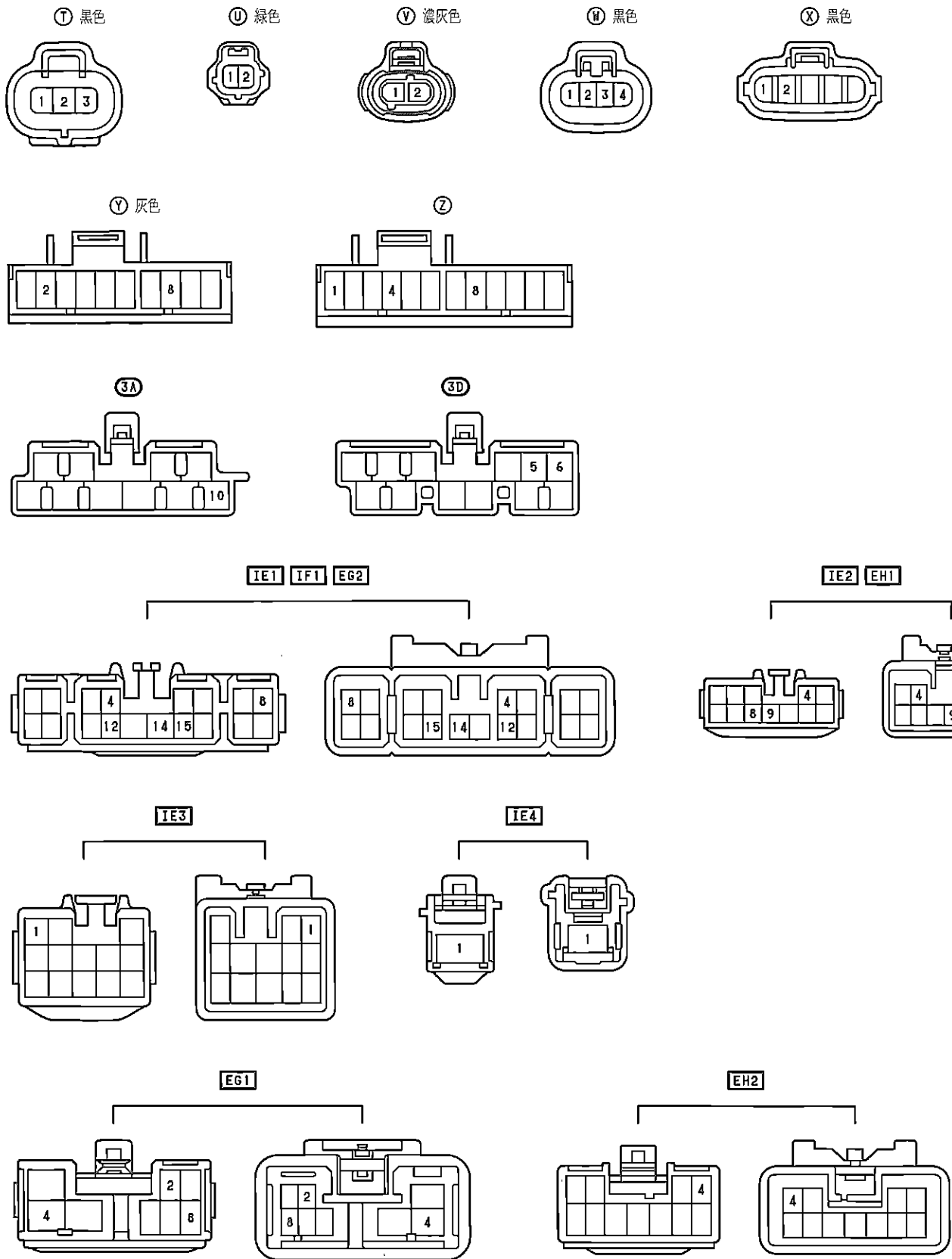



EFI (3S-GTE)

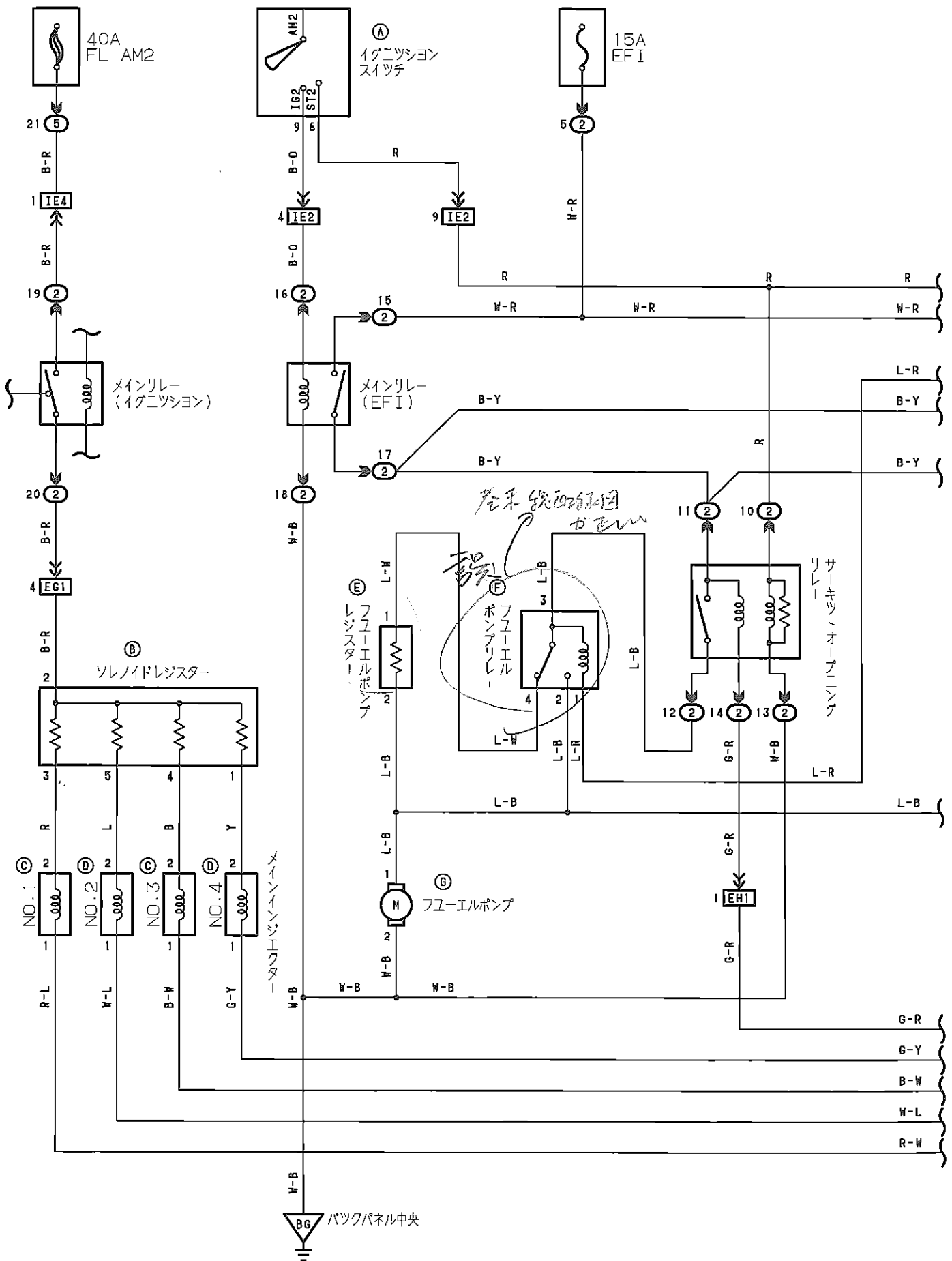

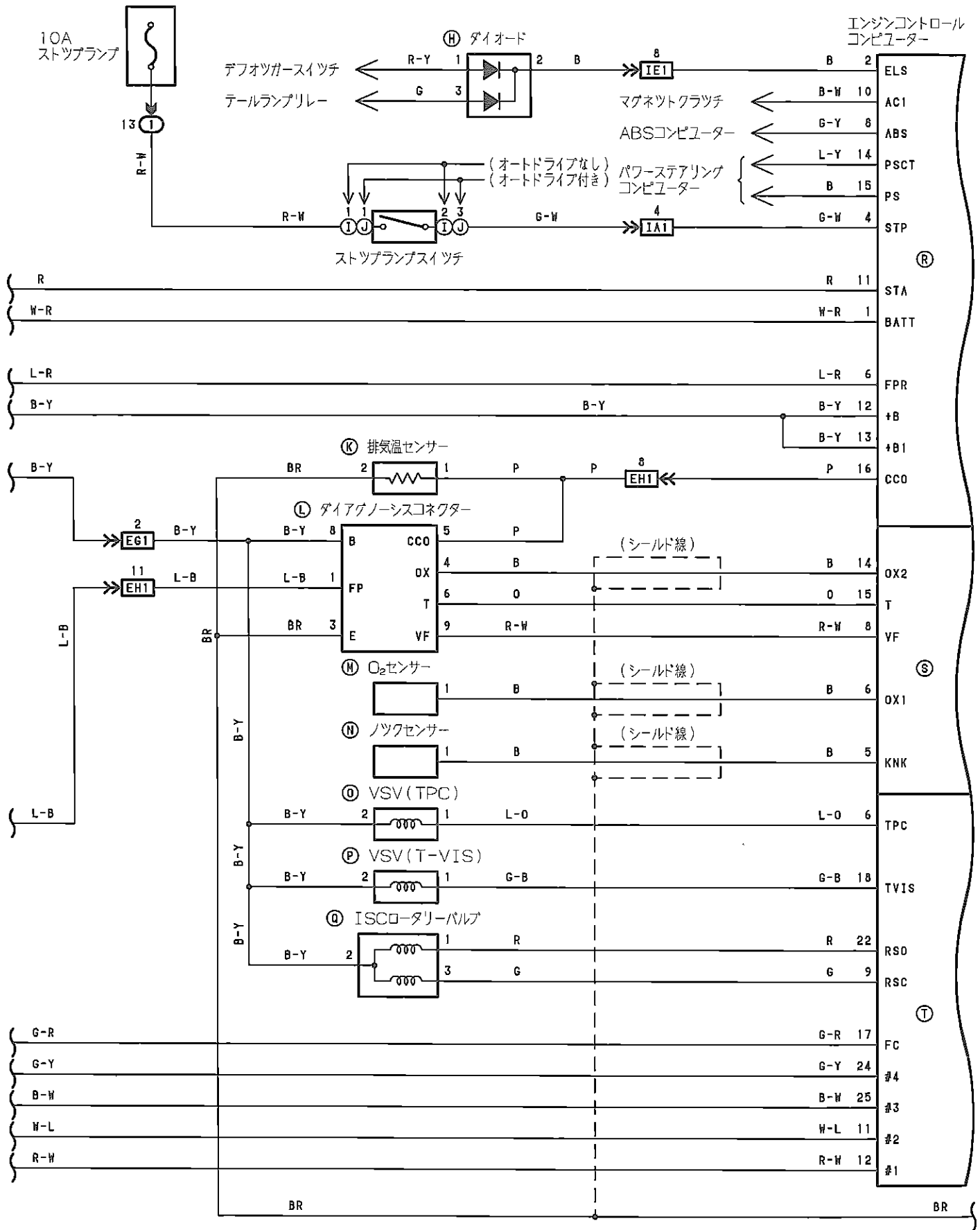



EFI (3S-GTE)

35

エンジンコントロール
コンピューター

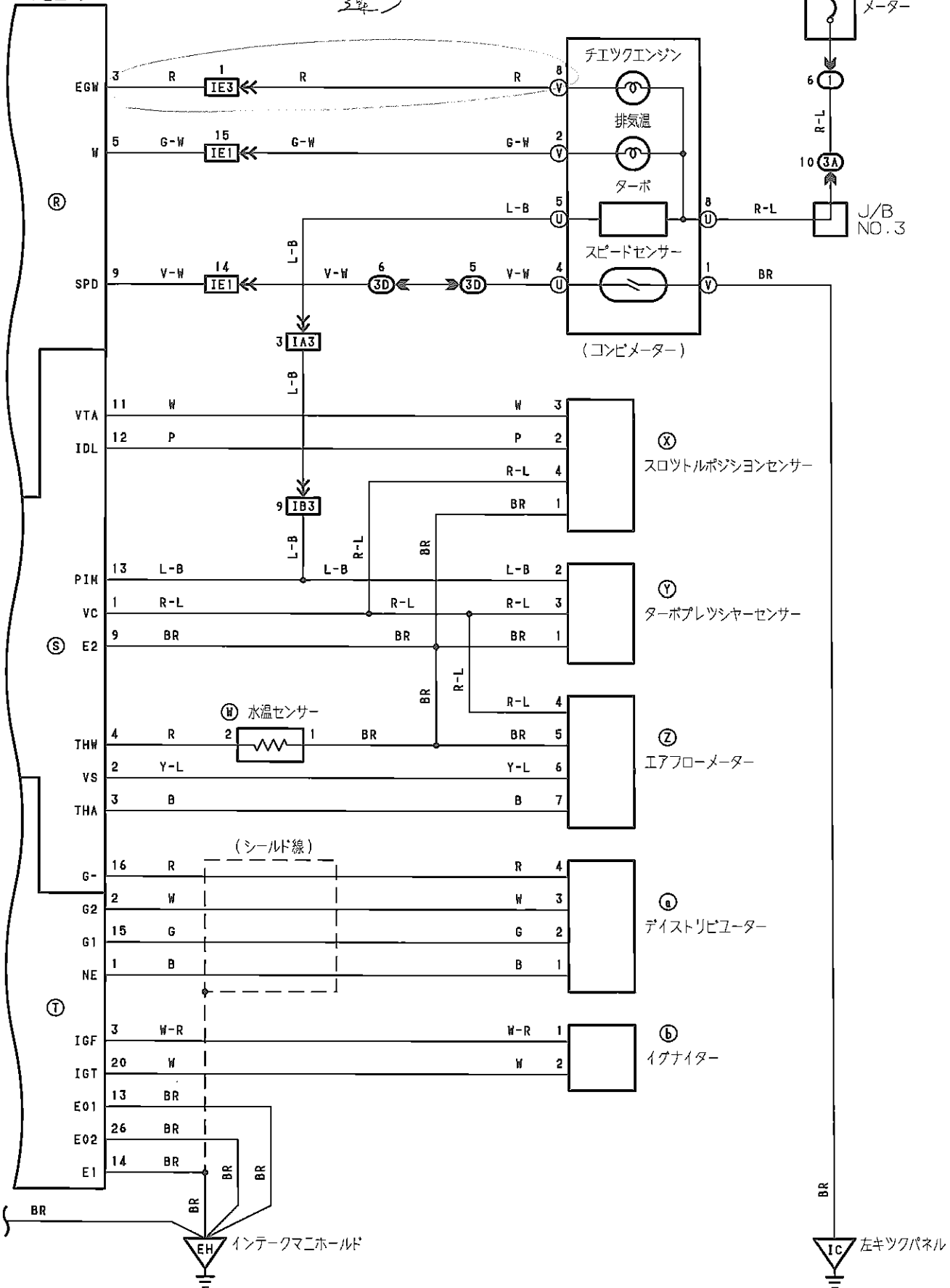

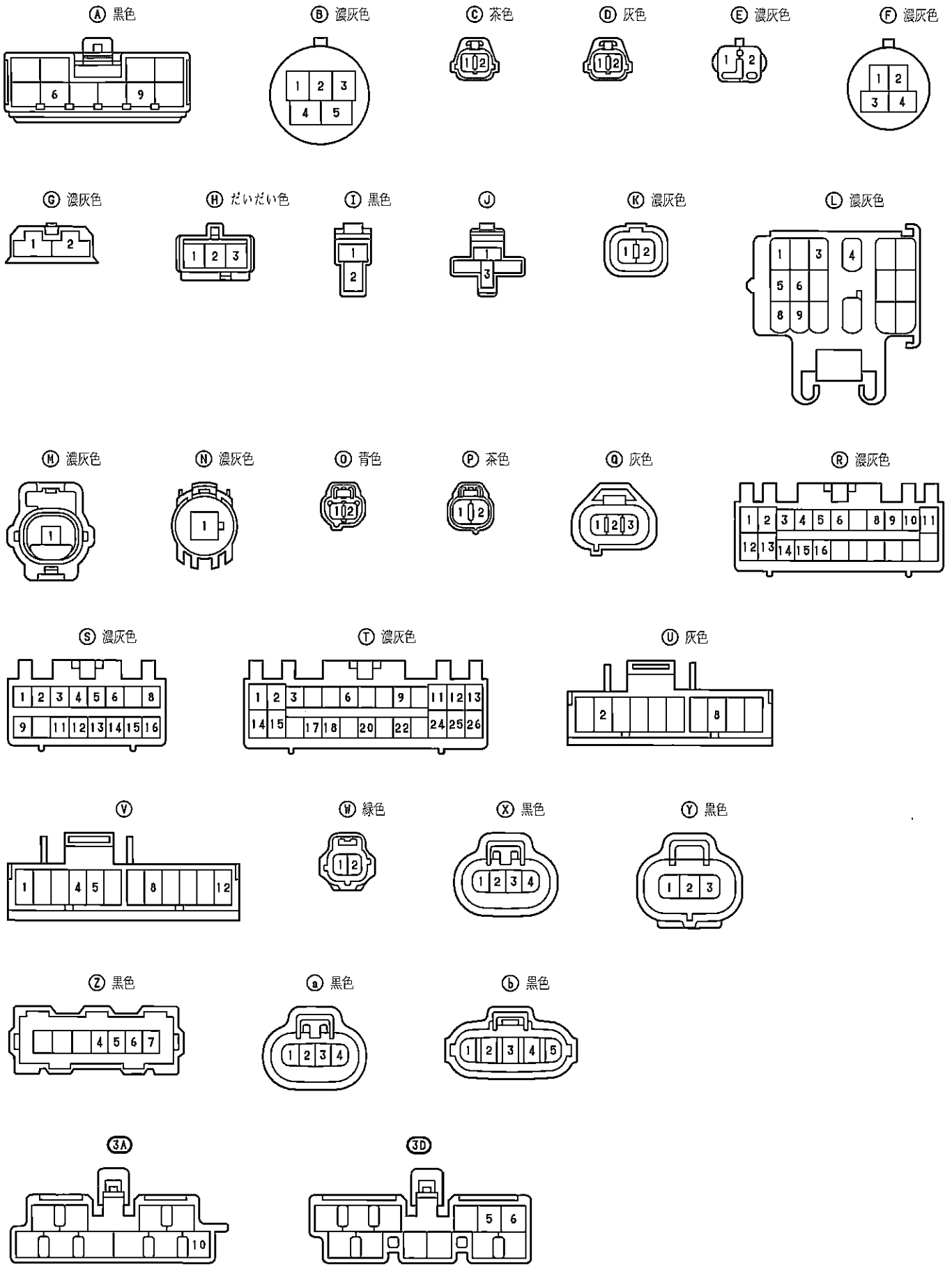



EFI (3S-GTE)

IA1

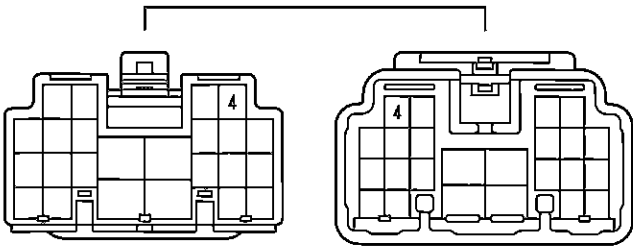

IA3 IE3

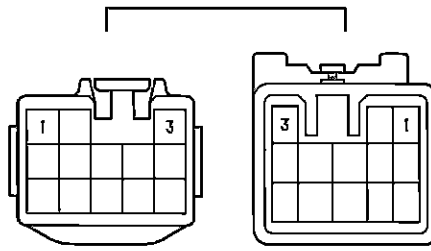

IB3

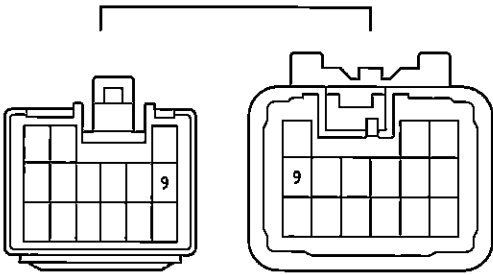

IE1

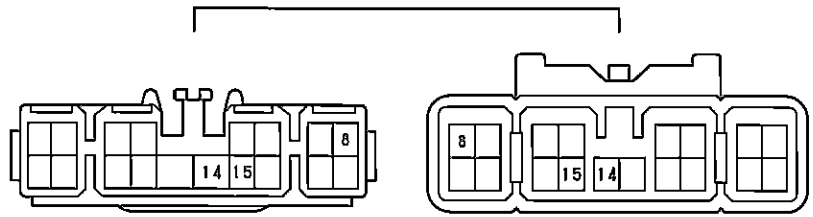

IE2 EH1

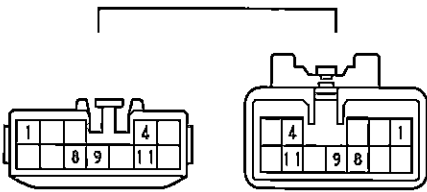

IE4

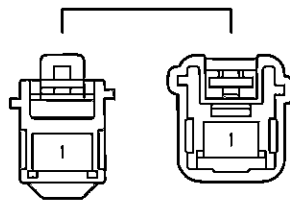

EG1

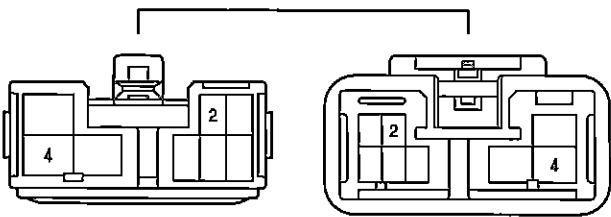

ラジエーターファン(エアコンなし)

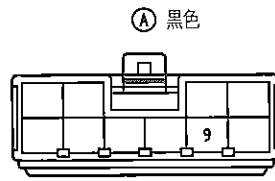
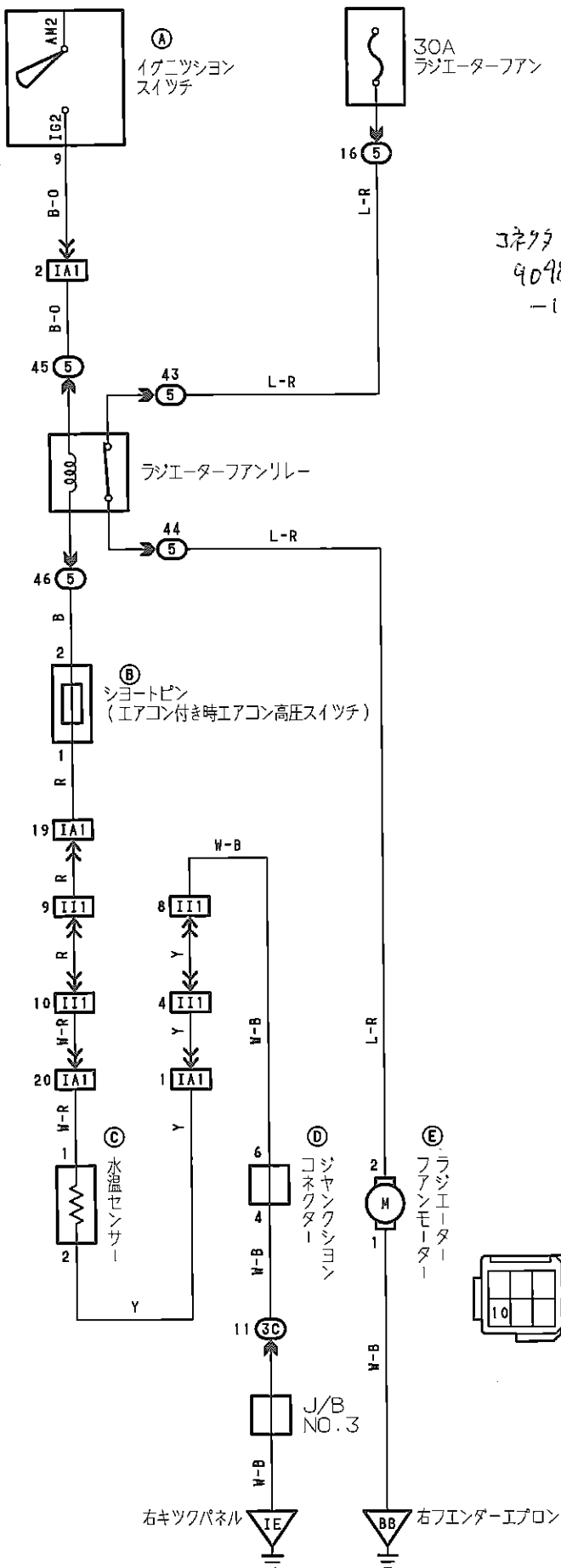

コネクタ (ワジワ) 90980 -10928

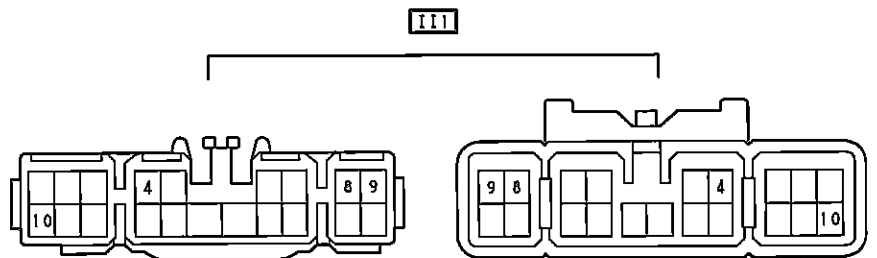
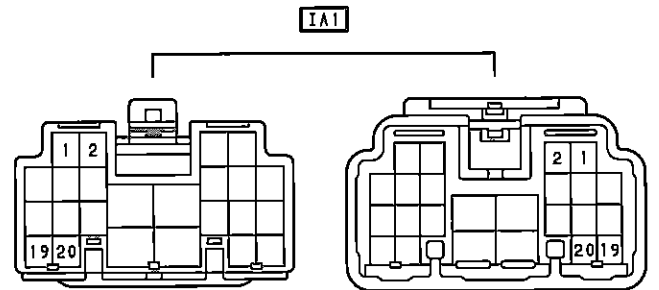
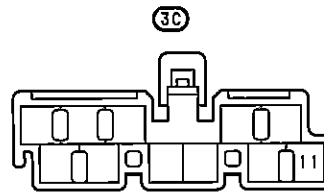
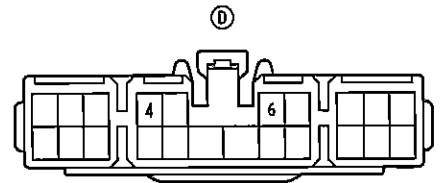



ヘッドランプ

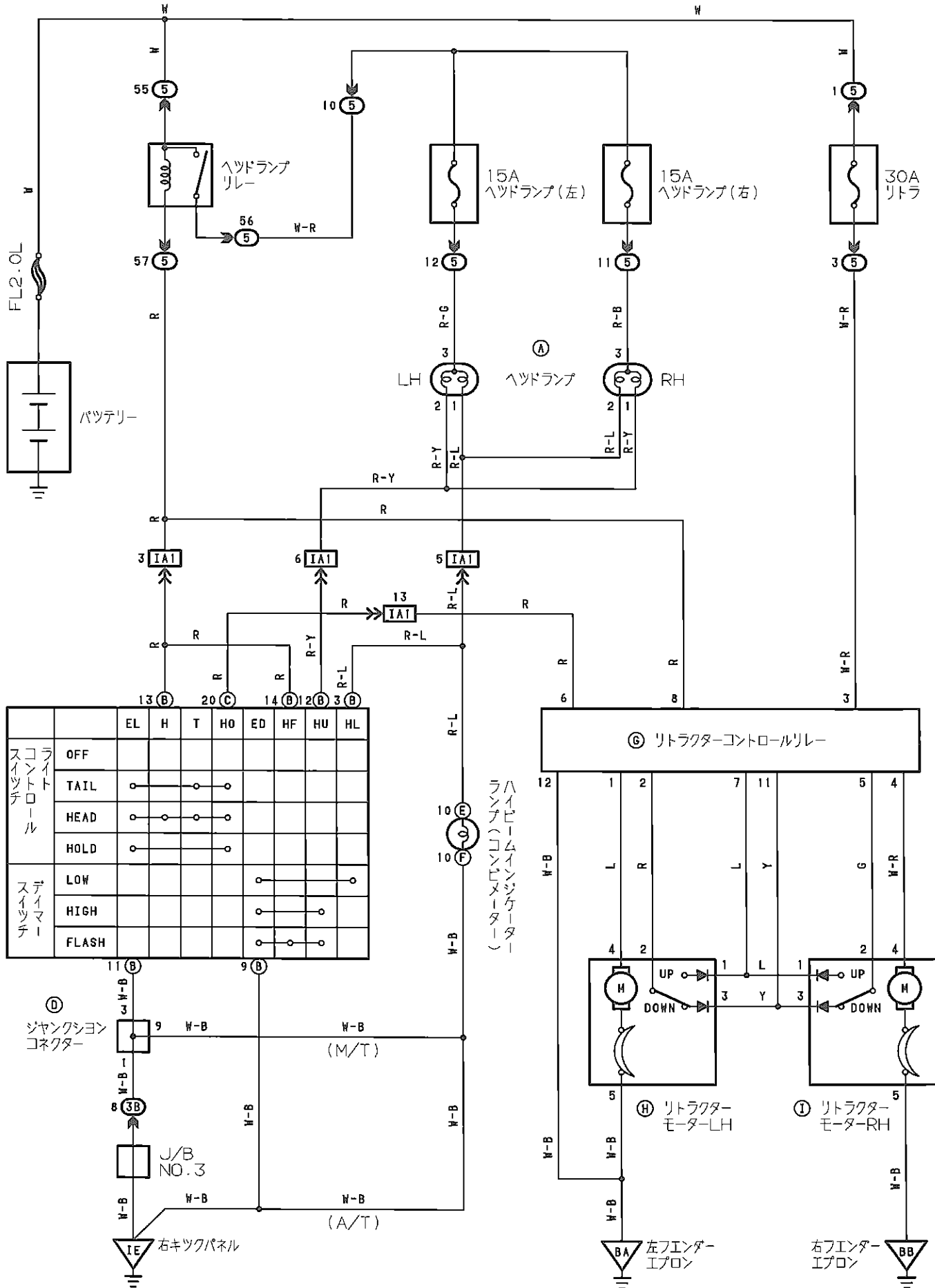

	EL	H	T	HO	ED	HF	HU	HL
スライツコントロール	OFF							
	TAIL	○	○	○				
	HEAD	○	○	○				
	HOLD	○	○	○				
デイマター	LOW				○		○	○
	HIGH				○		○	○
	FLASH				○		○	○

ハイビームインジケータ
ランプ(コンビメーター)

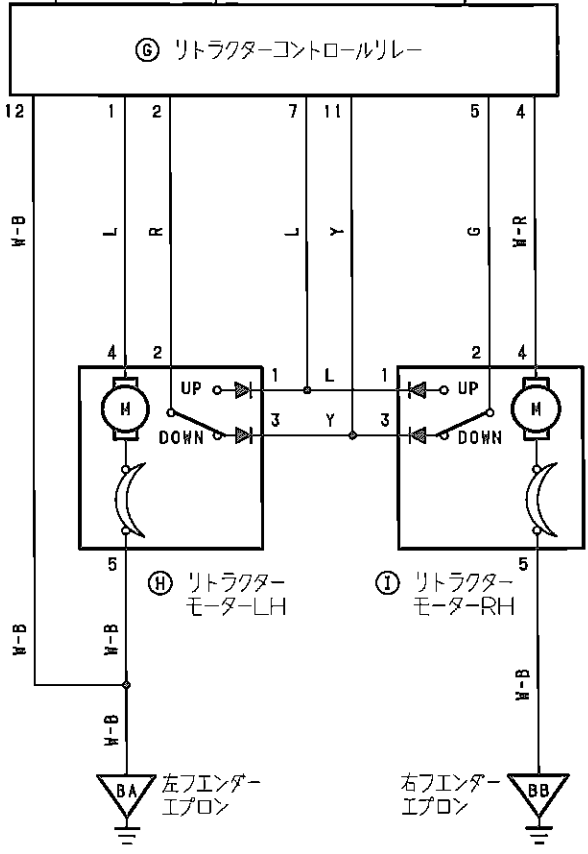

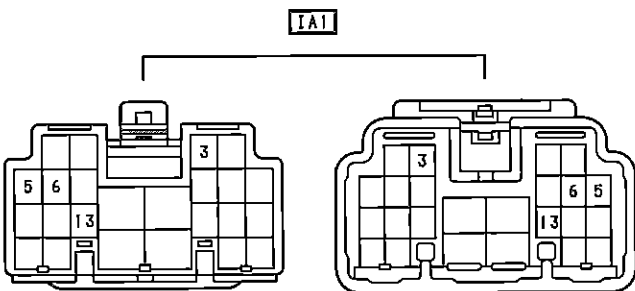
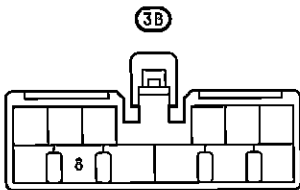
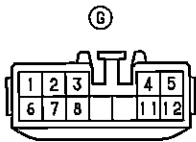
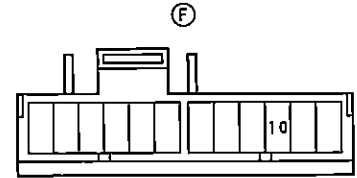
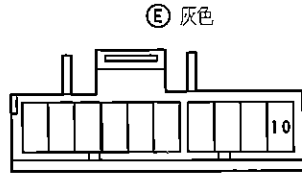
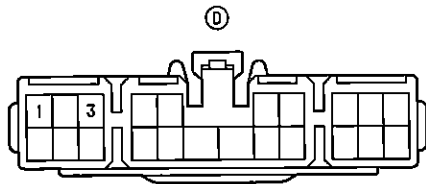
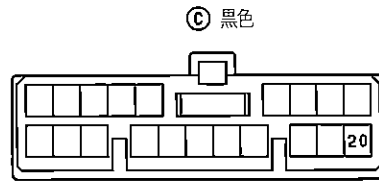
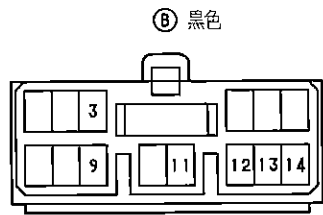
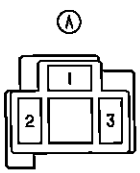

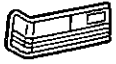

テールランプ

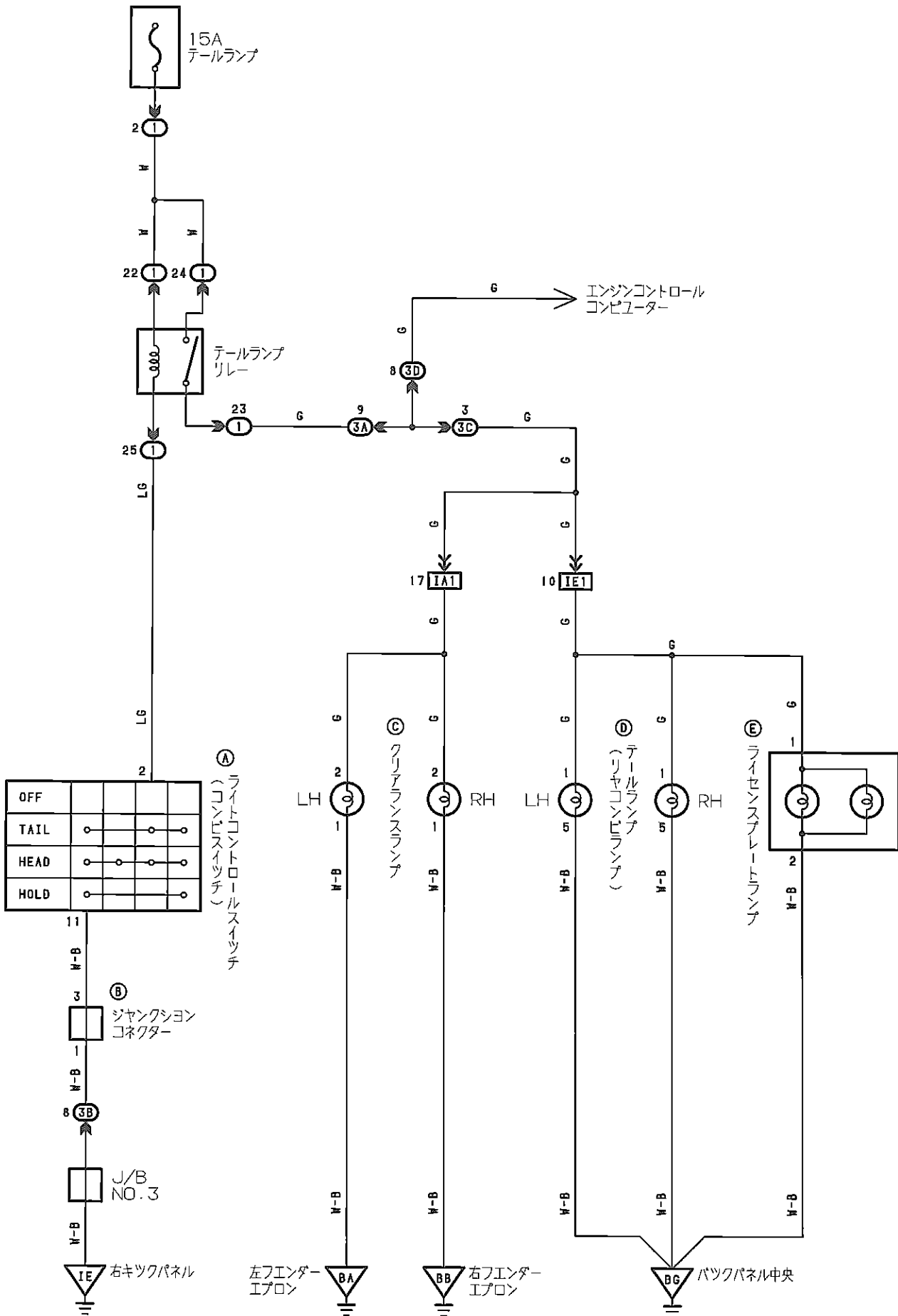

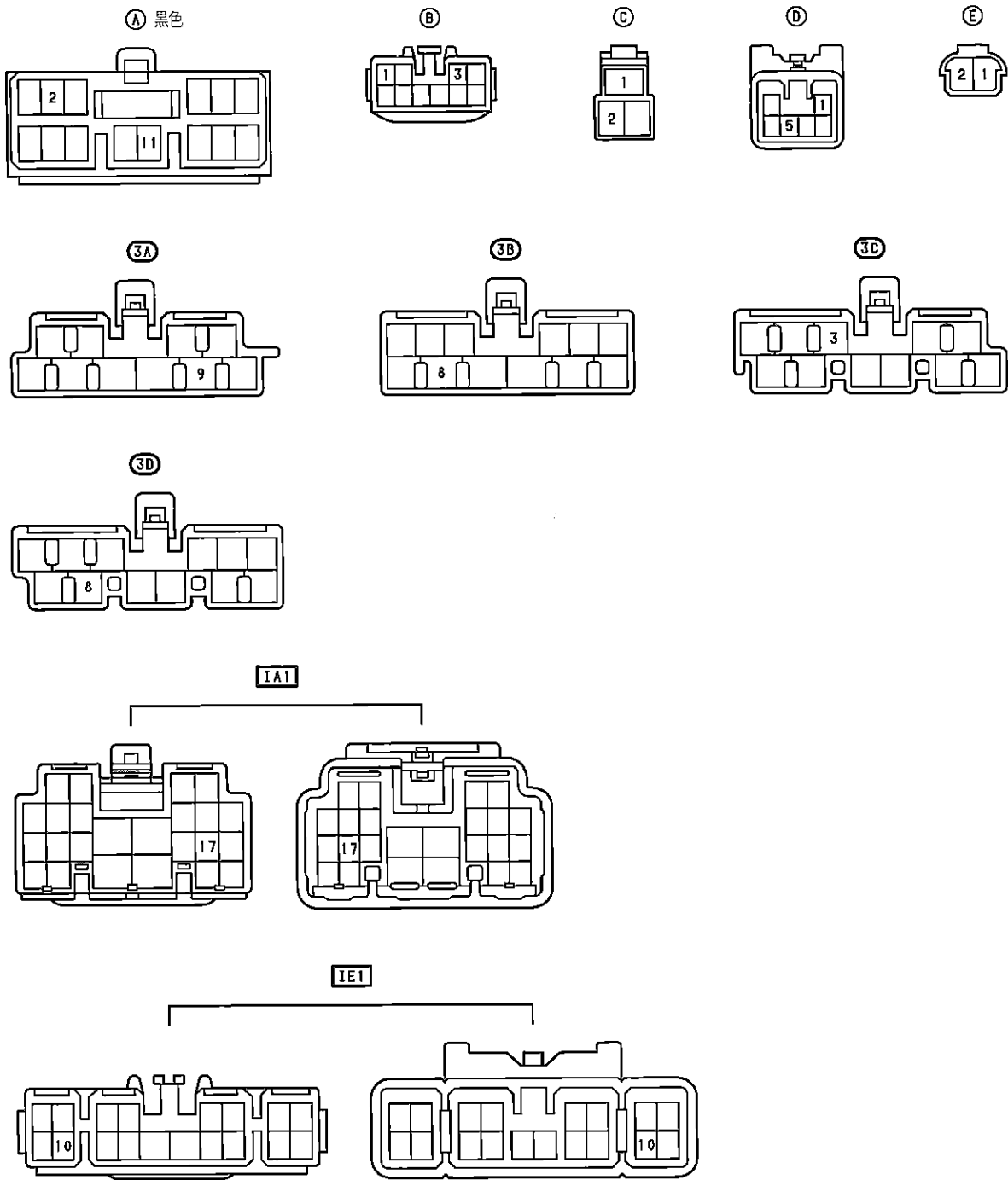

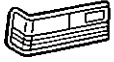

イルミネーション

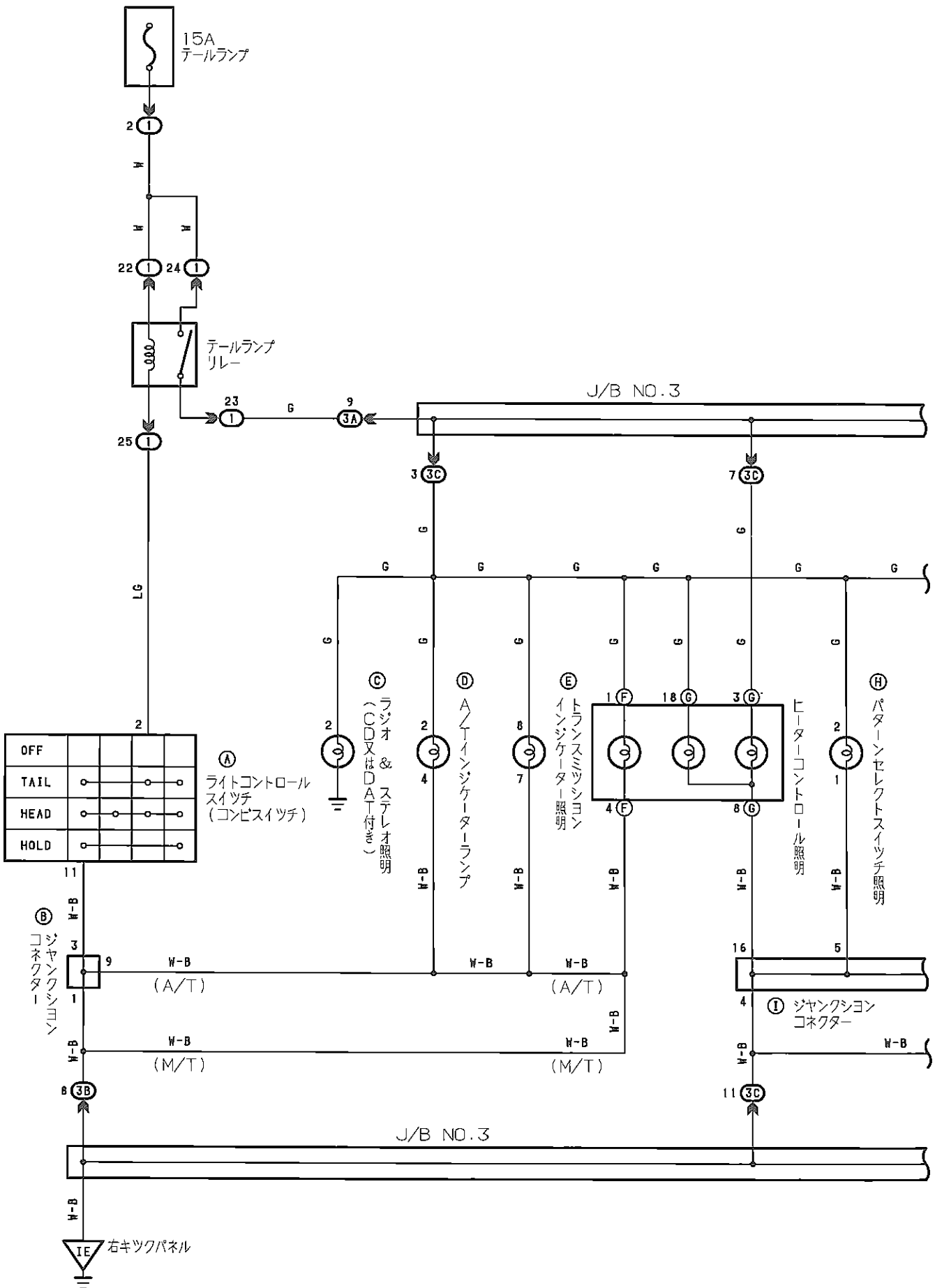

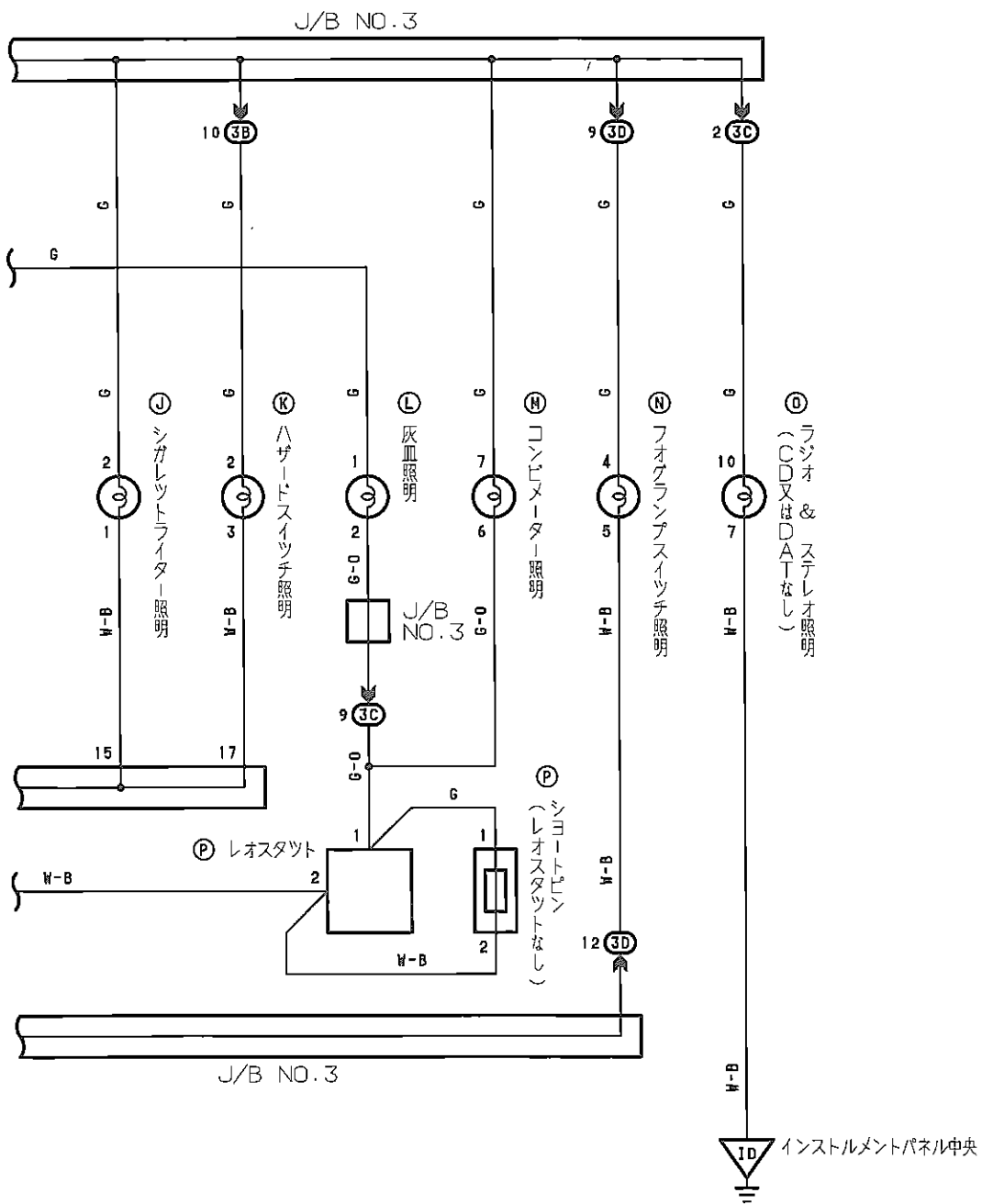

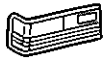

イルミネーション

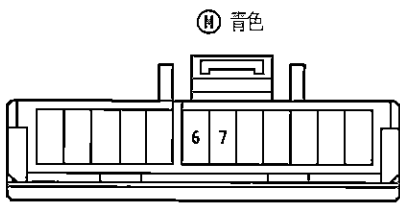
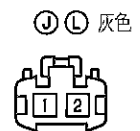
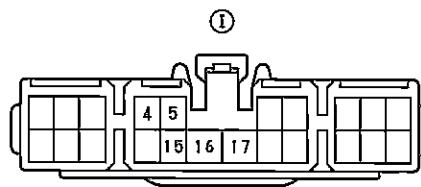
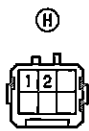
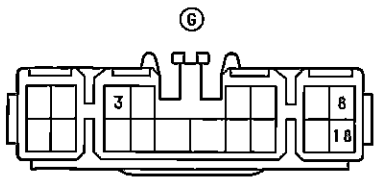
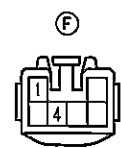
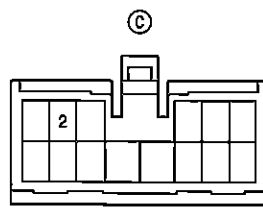
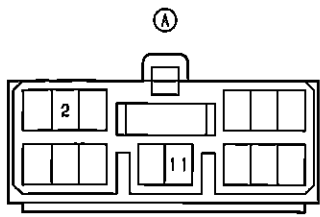

① 青色

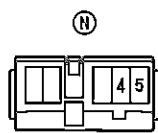

②

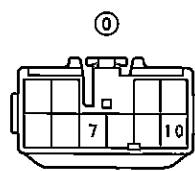

③

④ 黒色

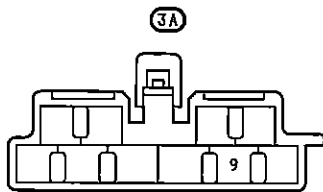

⑤A

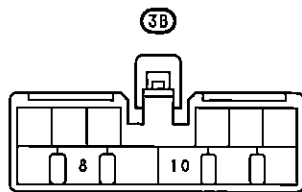

⑤B

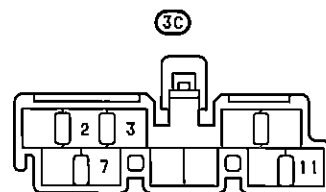

⑤C

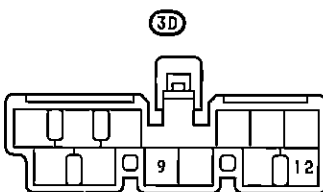

⑤D

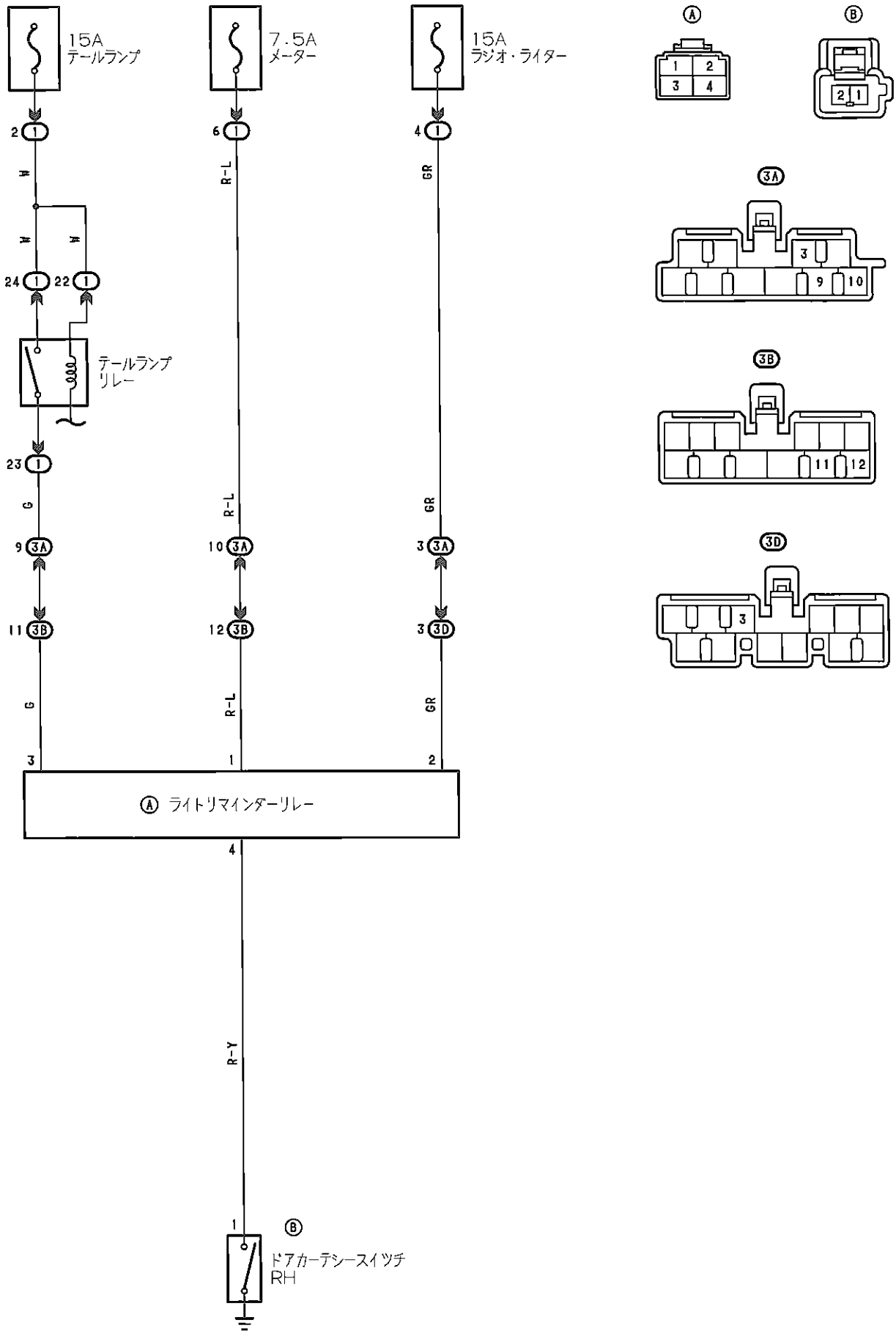



ターンシグナル & ハザード

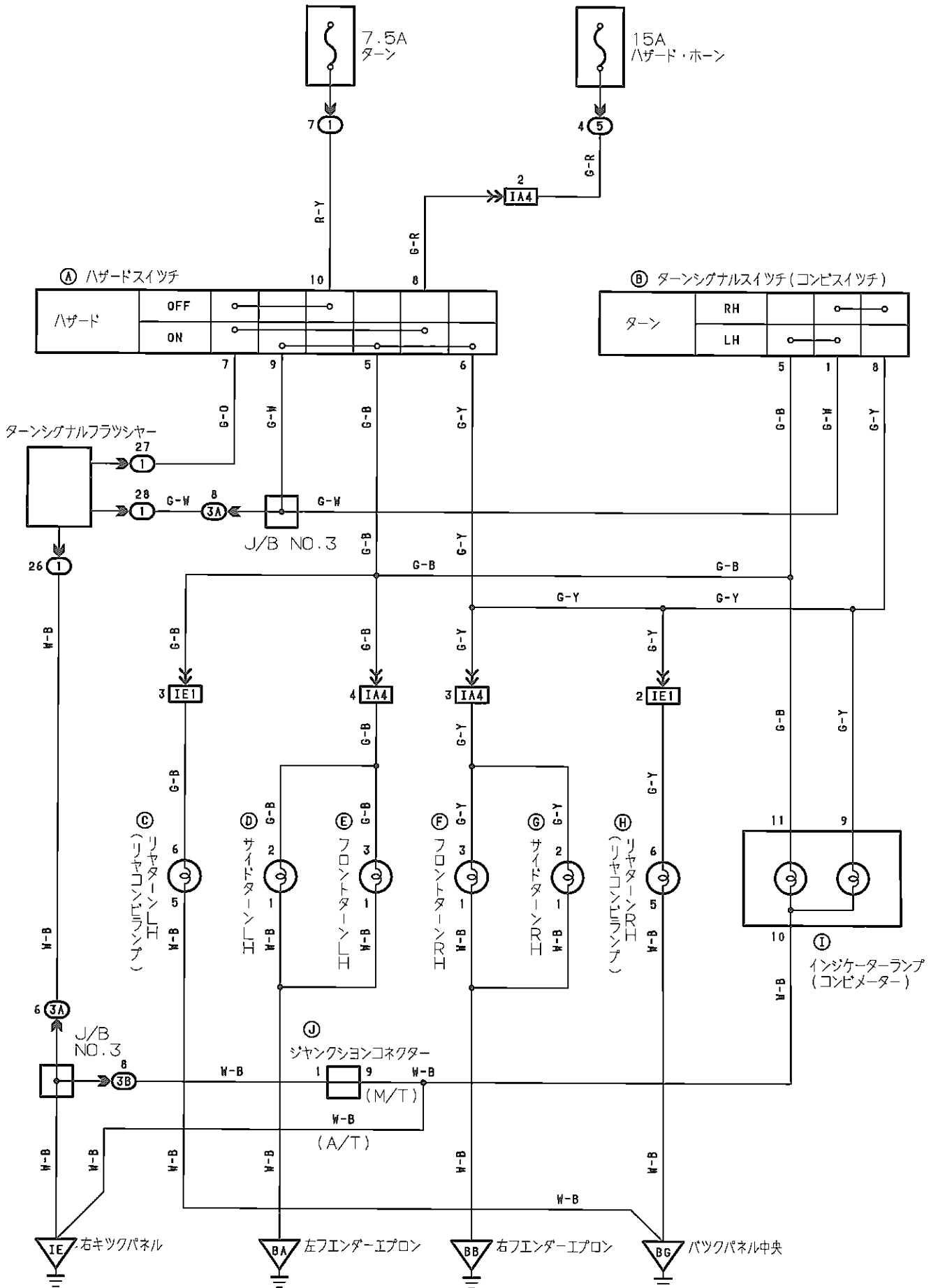

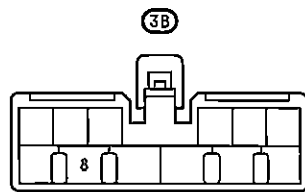
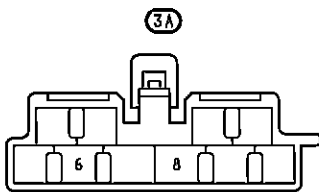
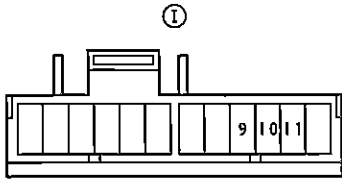
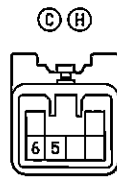
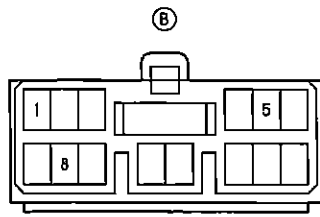
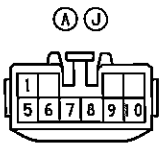

IA4

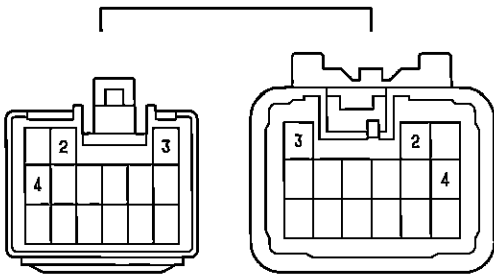

IE1

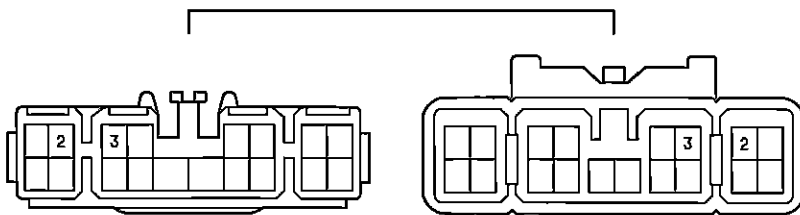

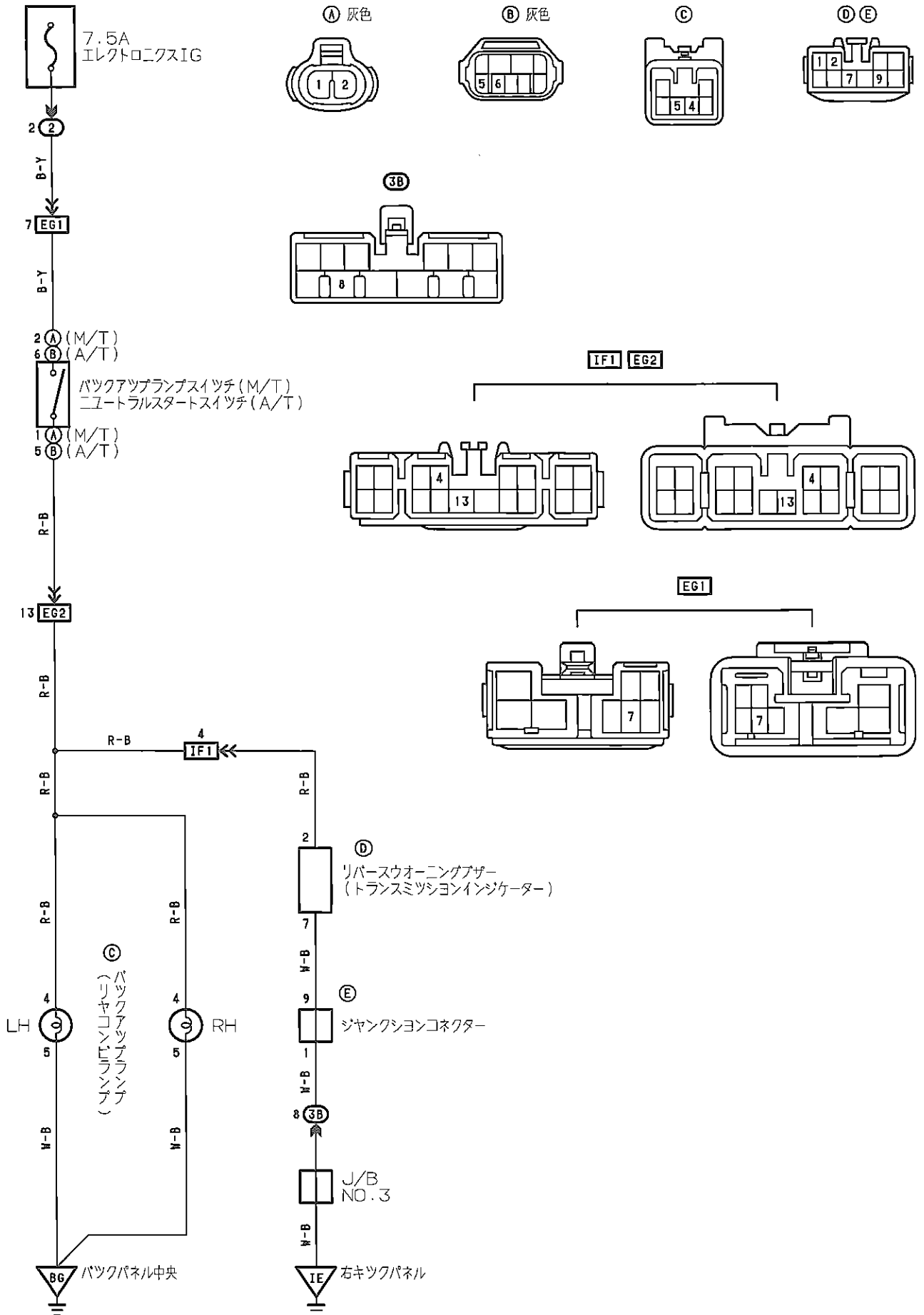



インテリアランプ

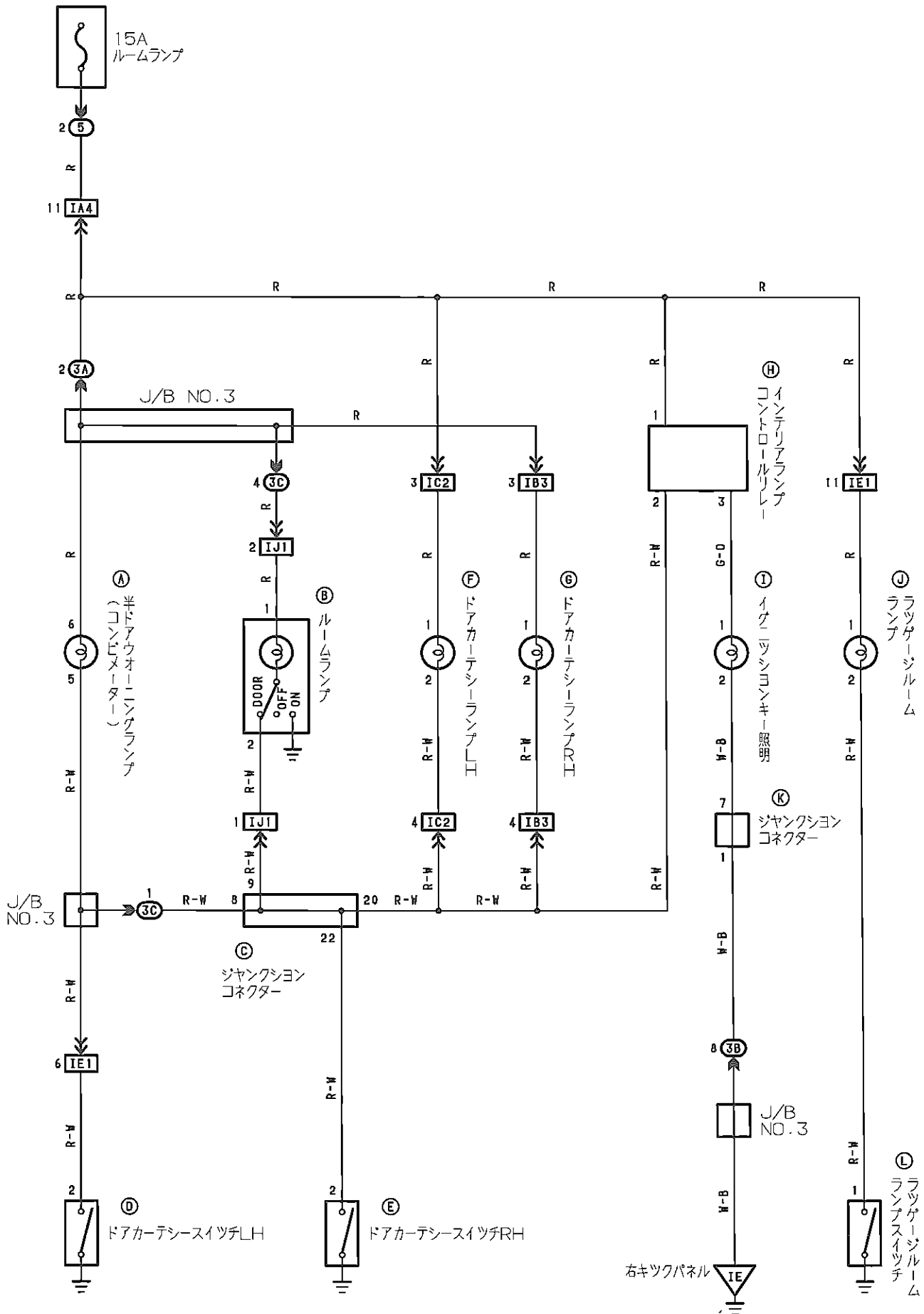

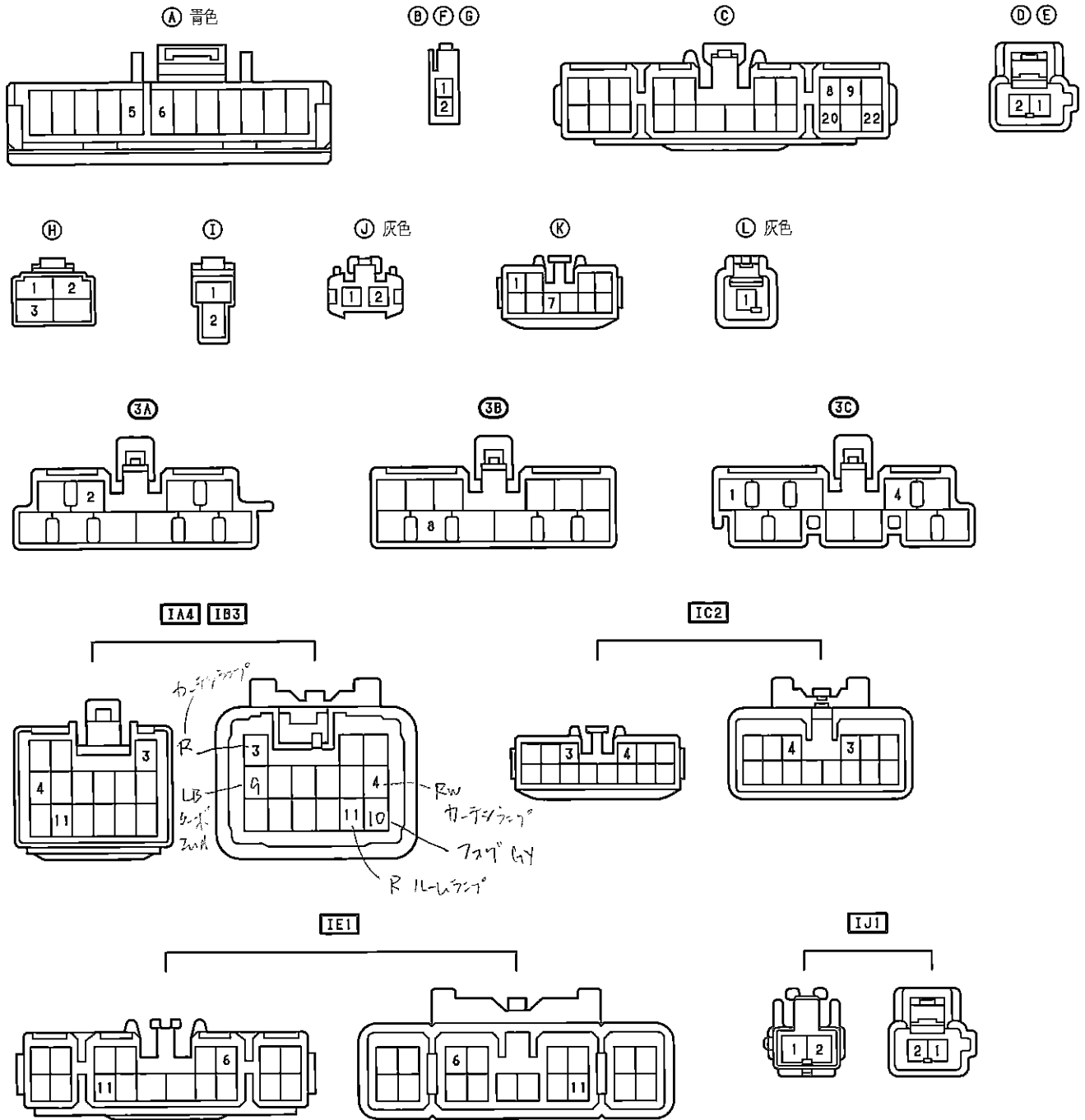



フォグランプ

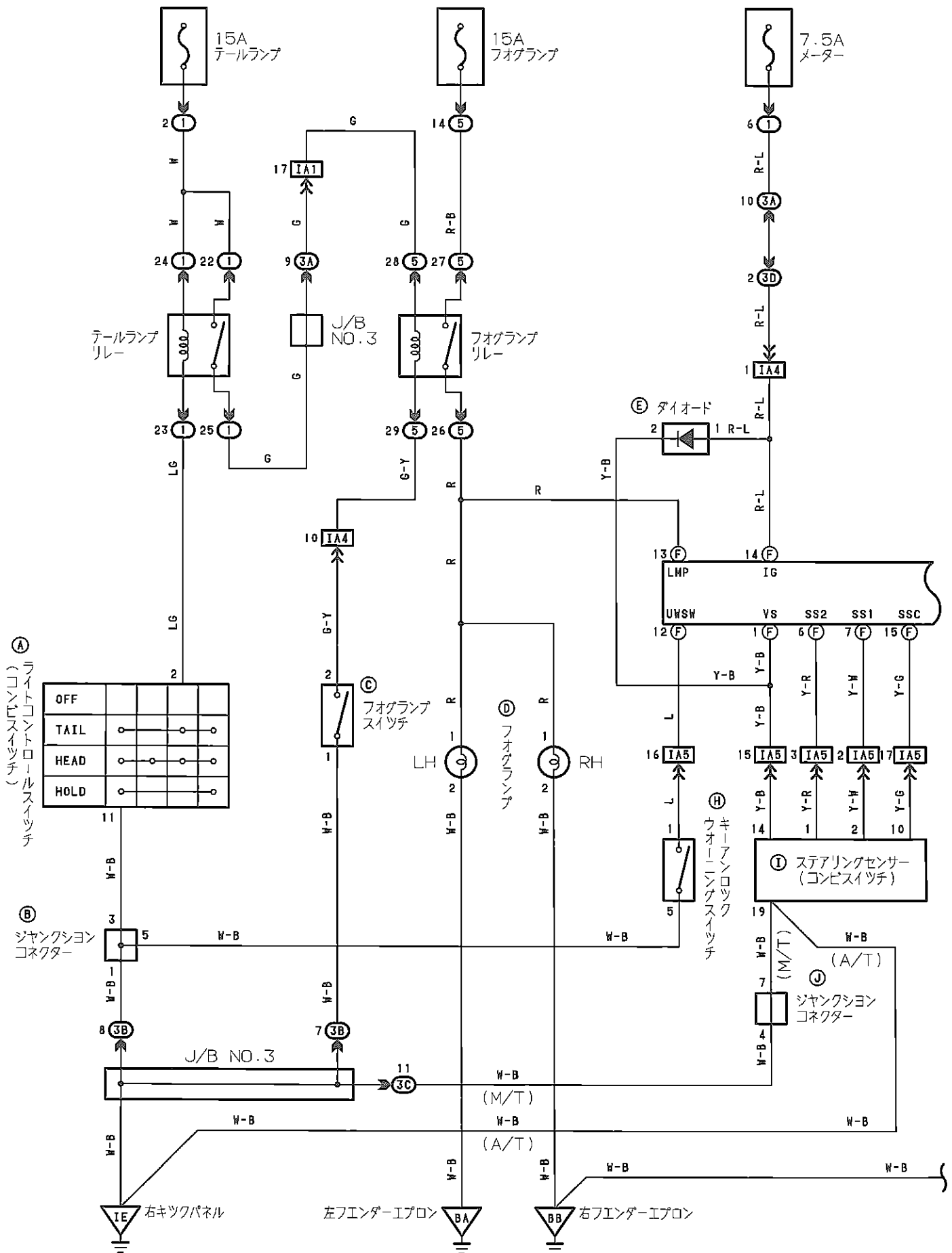

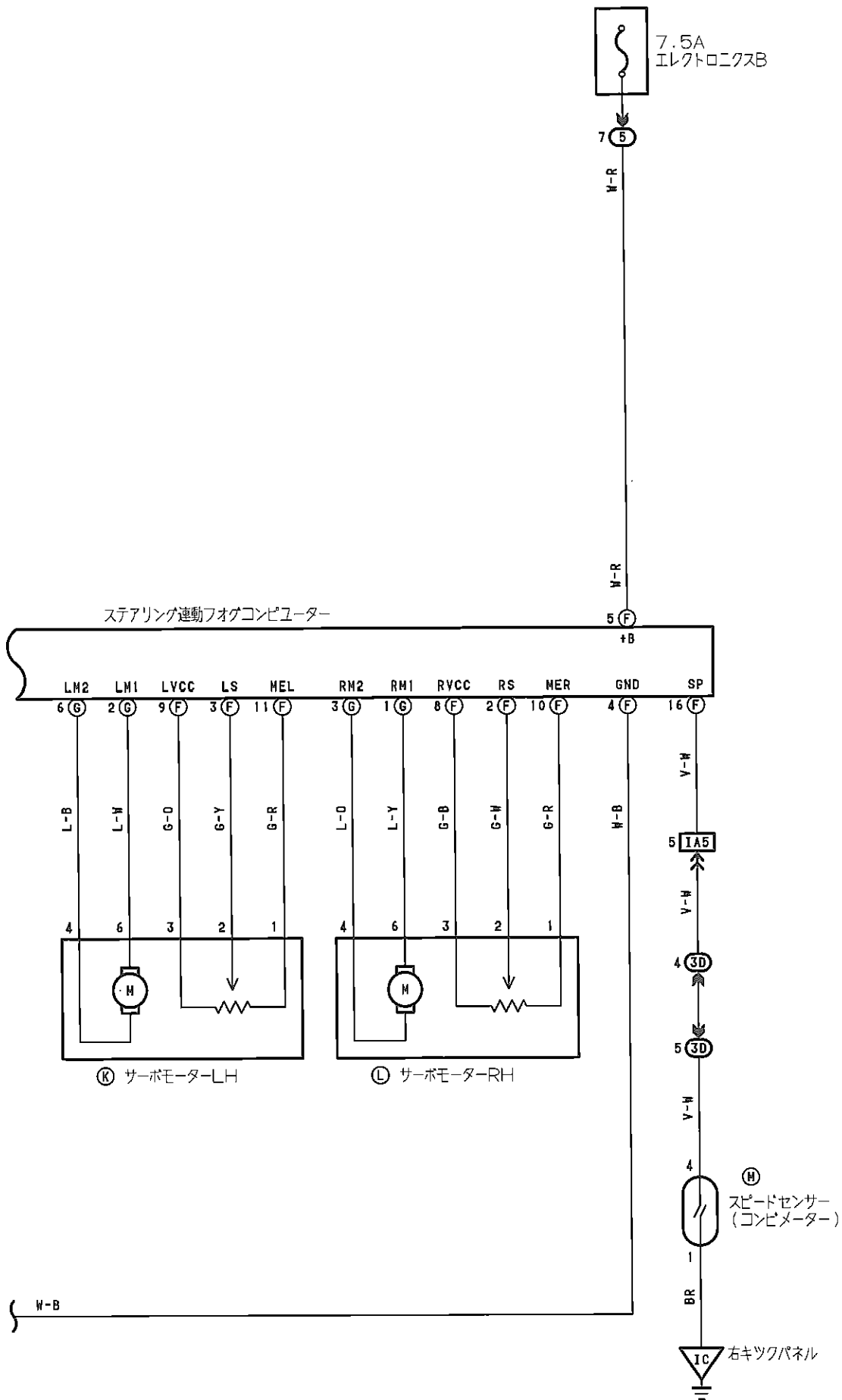



フオグランプ

Ⓐ

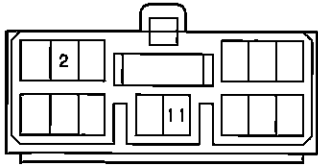

Ⓑ

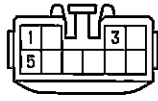

Ⓒ

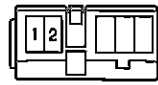

Ⓓ



Ⓔ 黒色



Ⓕ

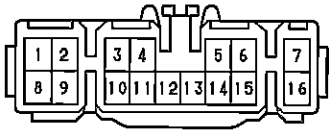

Ⓖ



Ⓗ 黒色

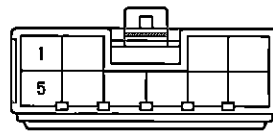

Ⓘ 黒色

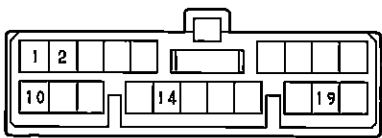

Ⓙ

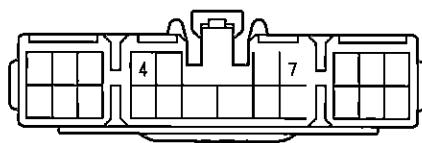

Ⓚ Ⓛ

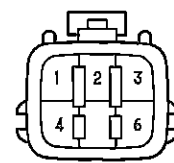

Ⓜ

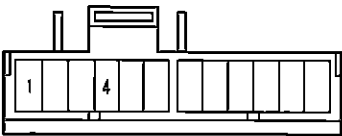

3A

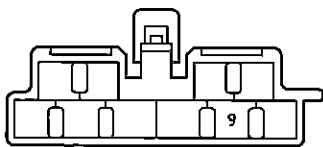

3B

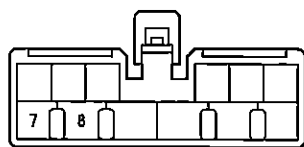

3C

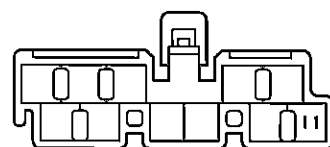

3D

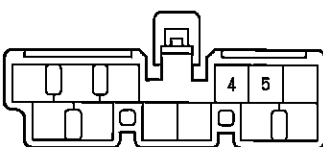

IA4

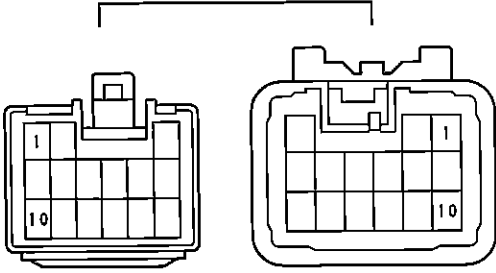

IA5

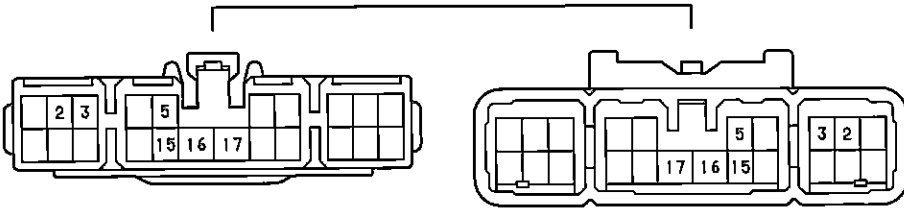

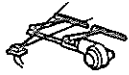

フロントワイパー & ウォッシャー

①

ワイパー & ウォッシャースイッチ
(コンビスイッチ)

	HIST	OFF	INT	LOW	HIGH	WASHER
W						○
EW						○
INT 2			○			
INT 1			○			
+S		○	○			
+1	○	○	○	○		
+2	○				○	
+B	○			○	○	

(スイッチ内蔵)
ウインドシールドワイパーリレー

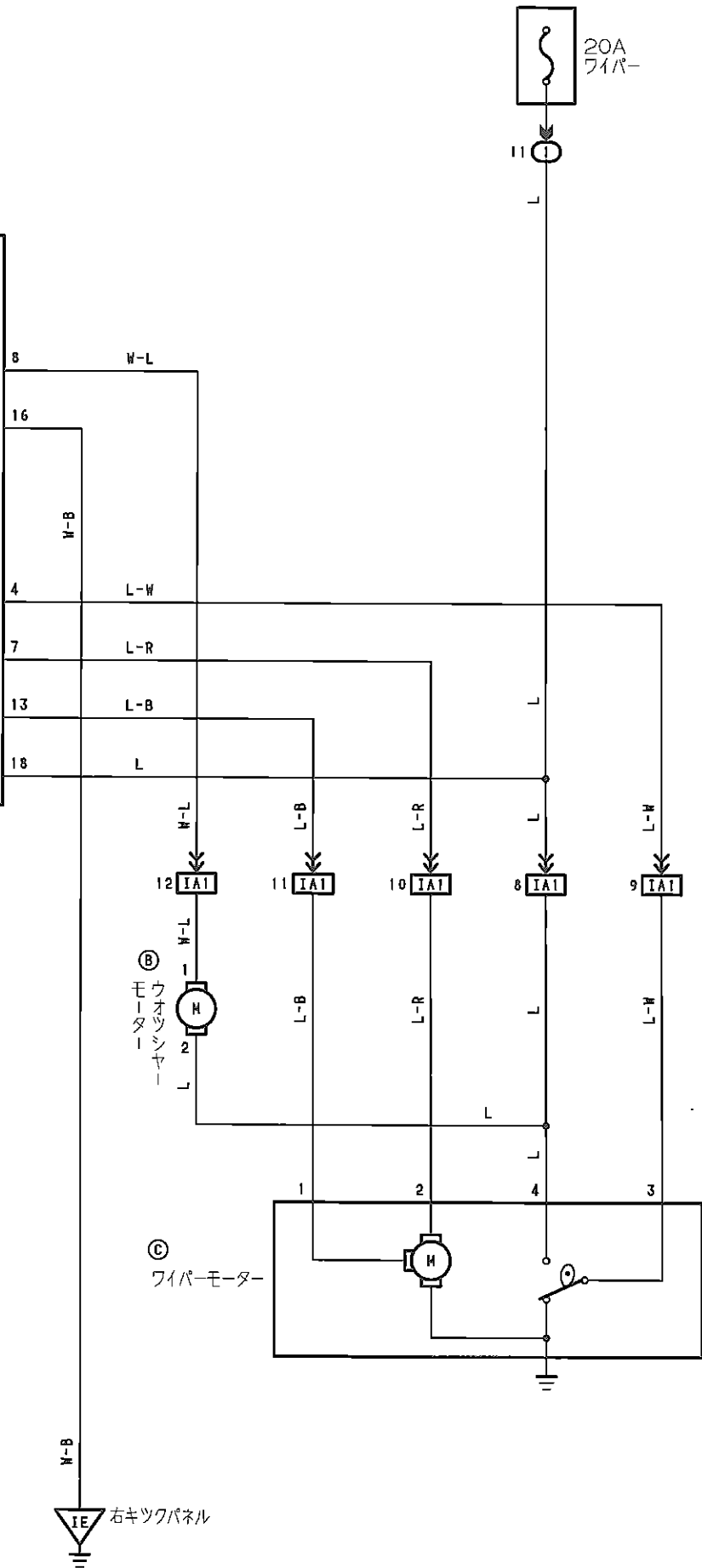

②

ウォッシャー
モーター

③

ワイパーモーター

右キツフパネル

Ⓐ 黒色

Ⓑ 黒色

Ⓒ 灰色

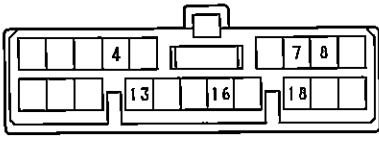

IAI

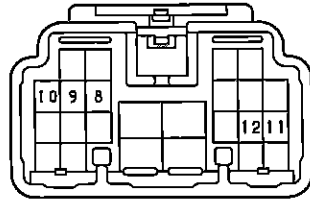
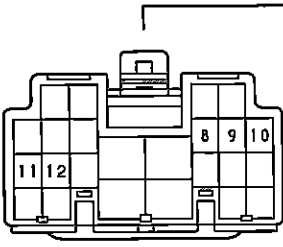

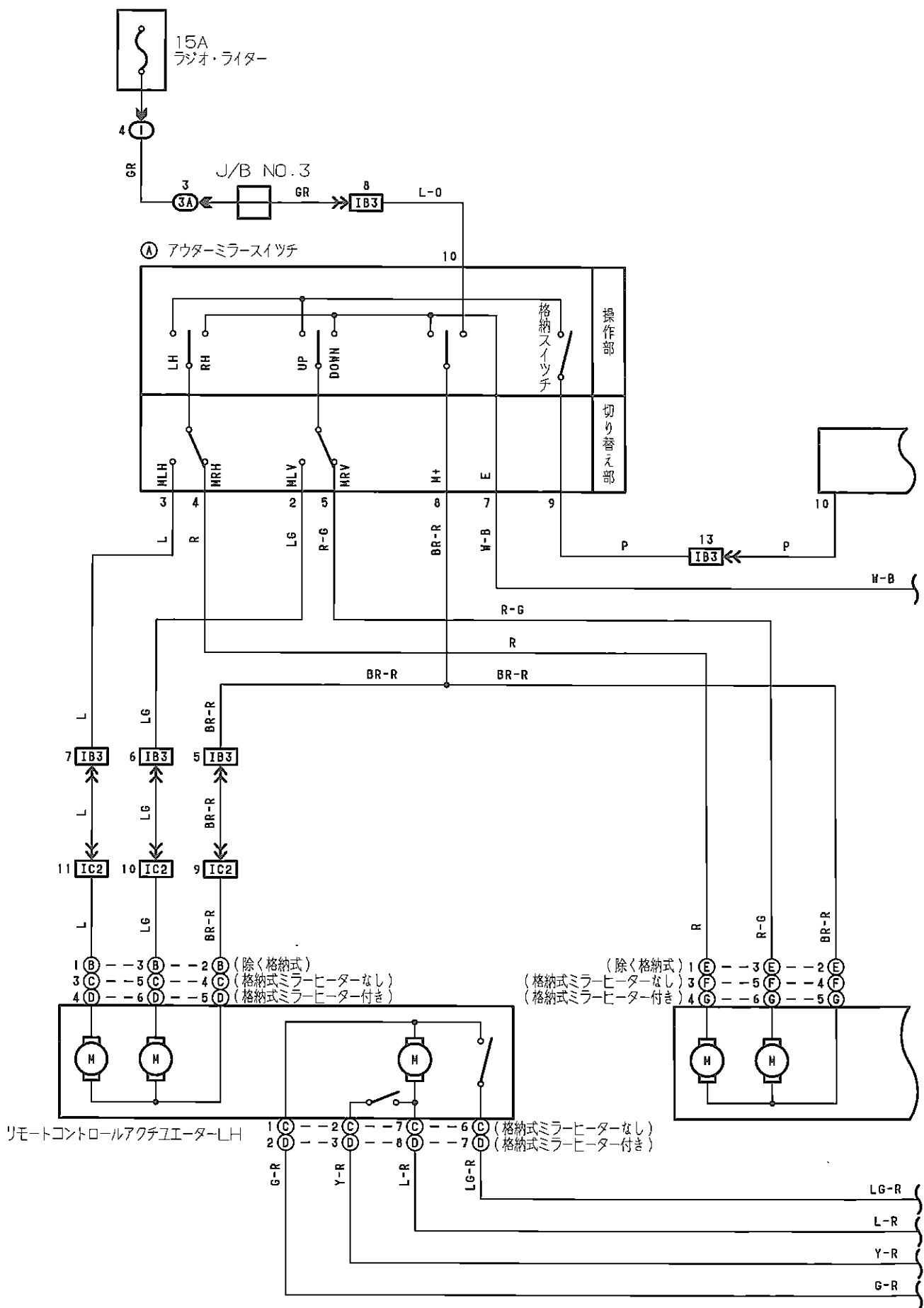

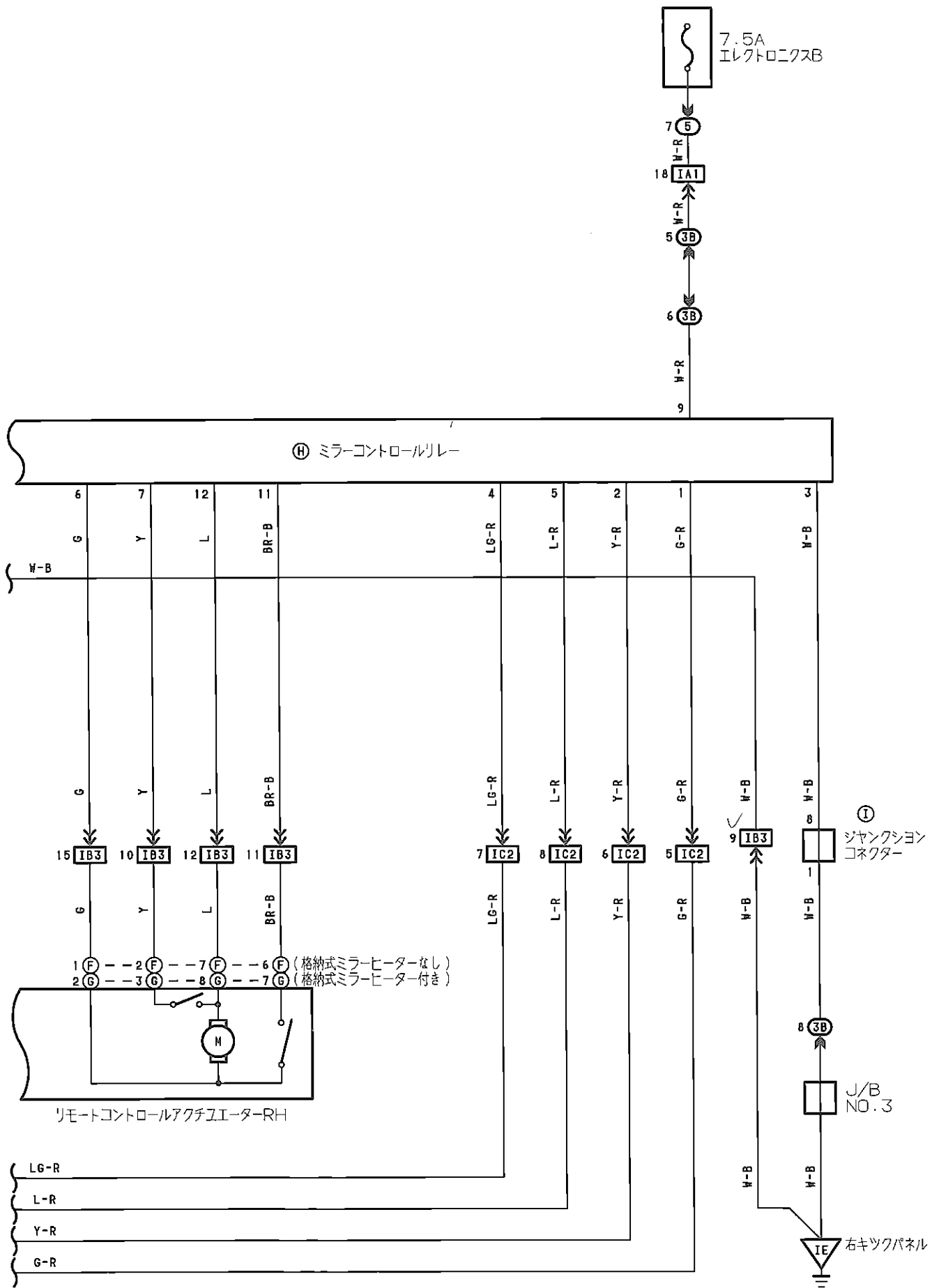

電動ミラー

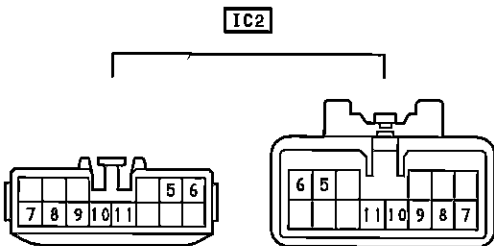
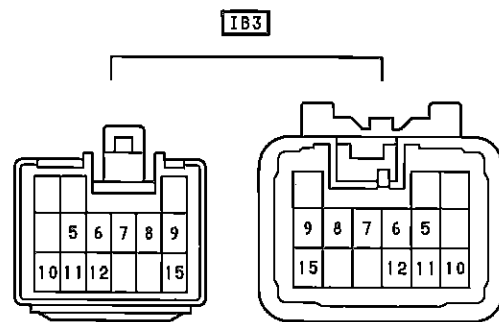
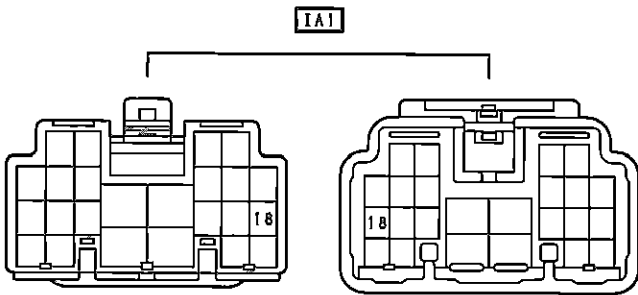
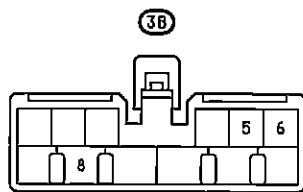
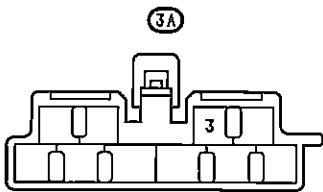
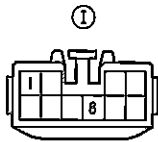
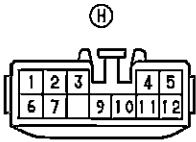
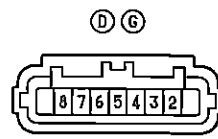
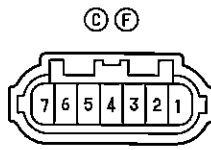
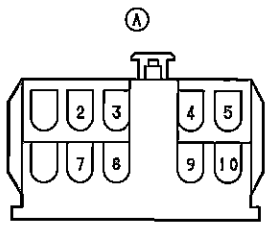

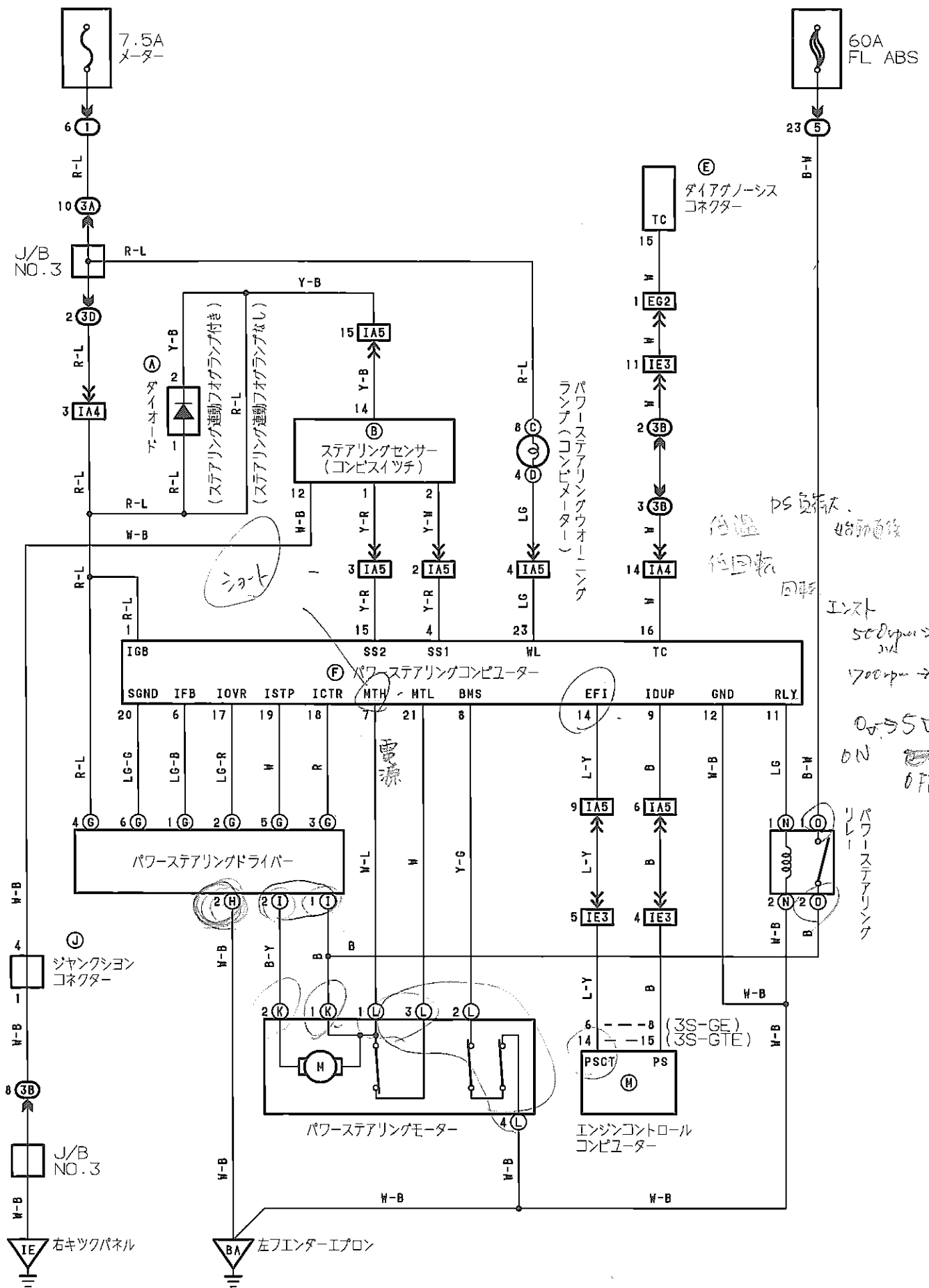



パワーステアリング

Ⓐ 黒色



Ⓑ 黒色

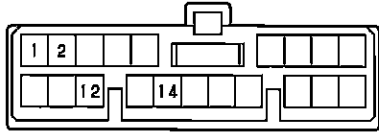

Ⓒ

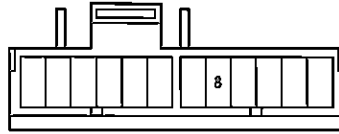

Ⓓ 灰色

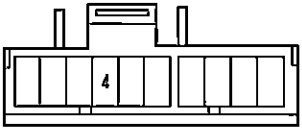

Ⓔ 濃灰色

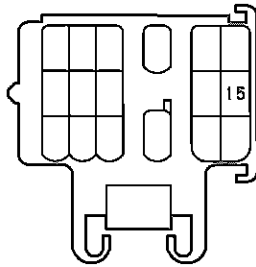

Ⓕ IFB 7002-7

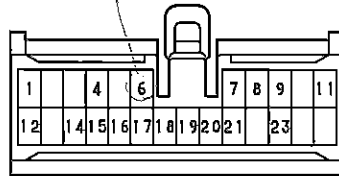

IFB トライバル Ⓖ 灰色



Ⓗ Ⓚ 灰色

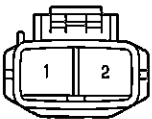

Ⓛ Ⓞ 灰色



Ⓜ



Ⓝ 灰色



Ⓢ 濃灰色

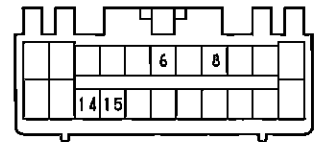

Ⓝ



ⓐ

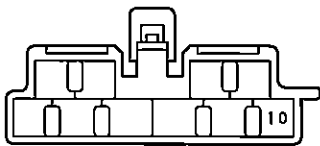

ⓑ

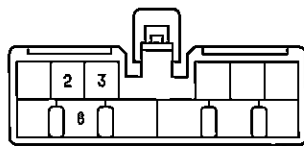

ⓓ

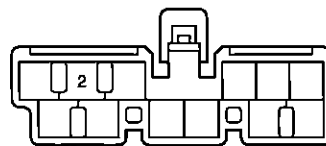

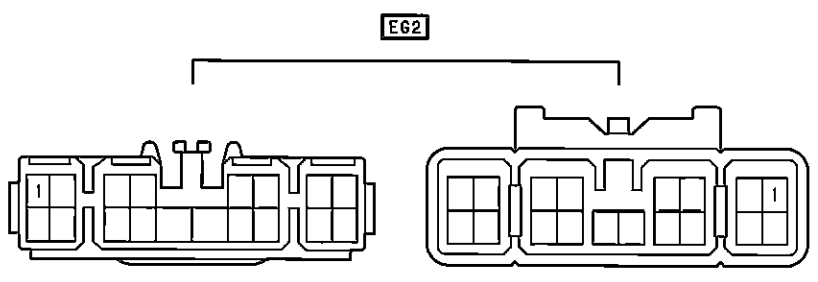
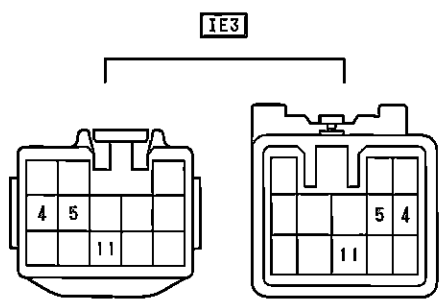
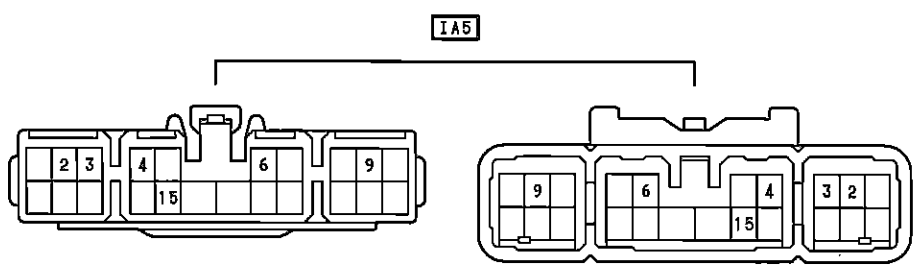
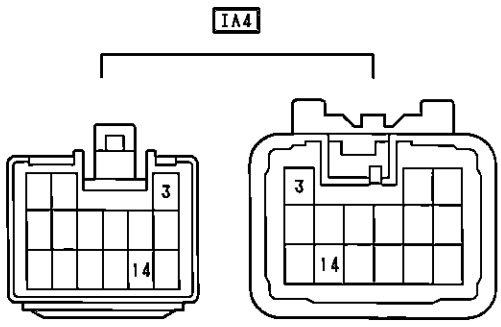



リヤウインドデフォツガー & ミラーヒーター

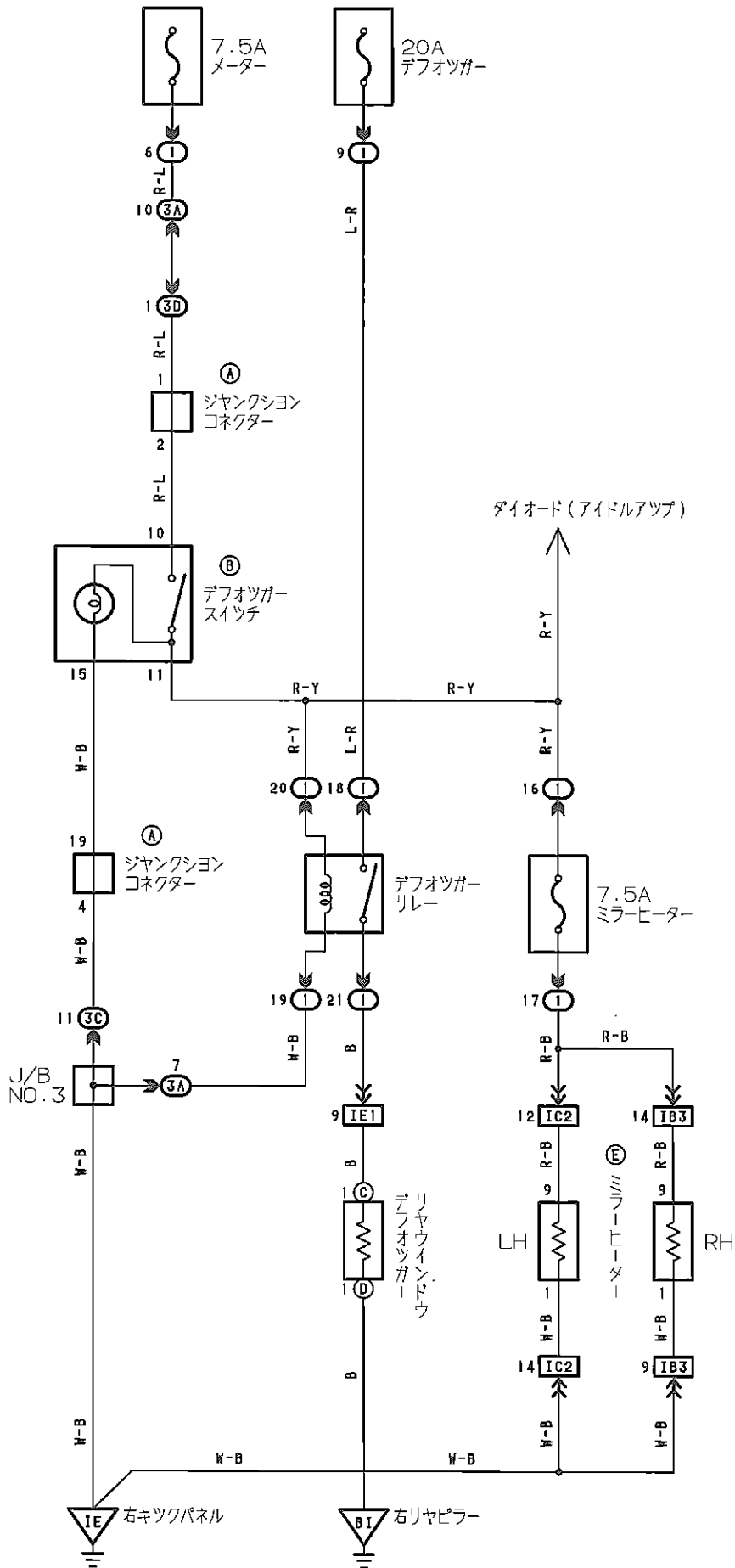

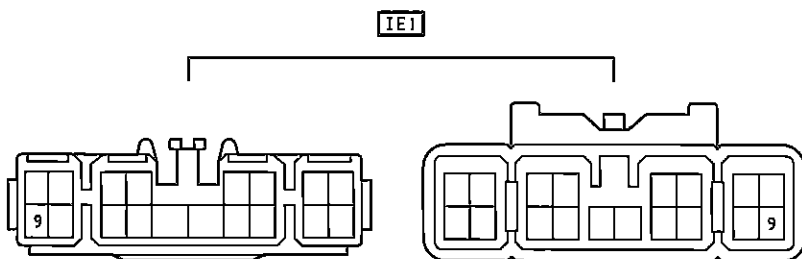
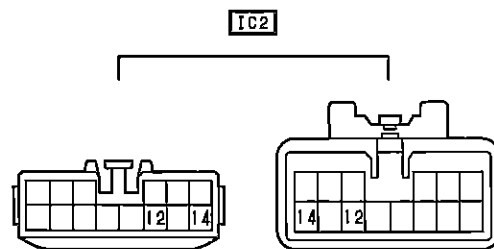
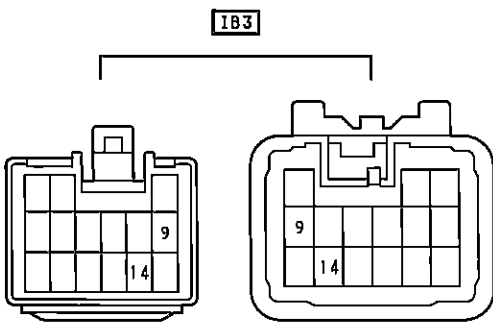
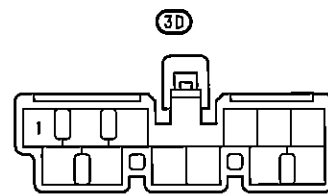
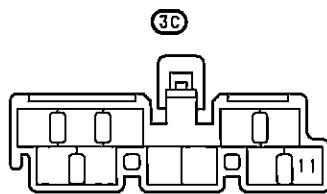
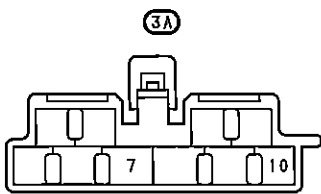
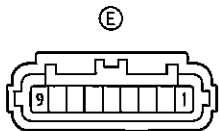
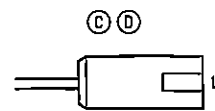
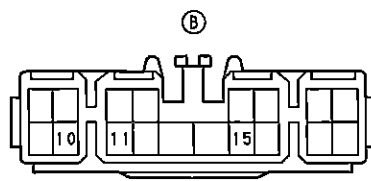
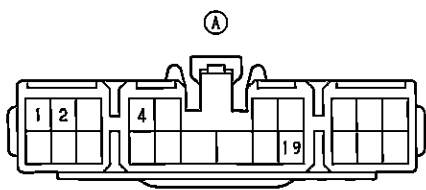

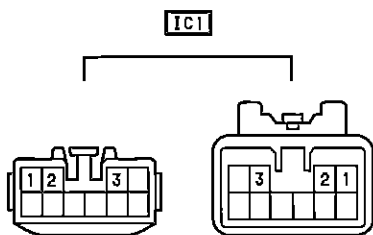
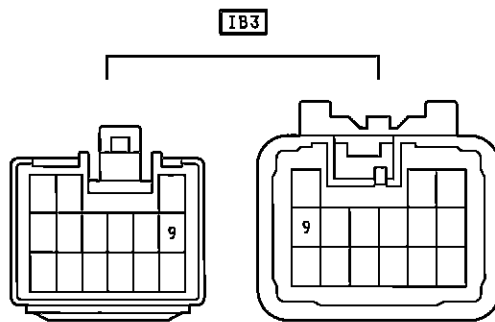
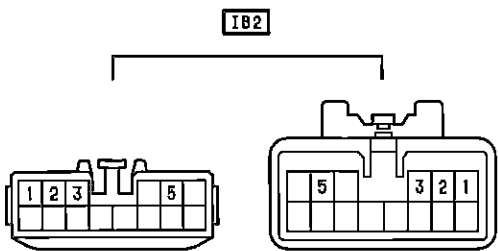
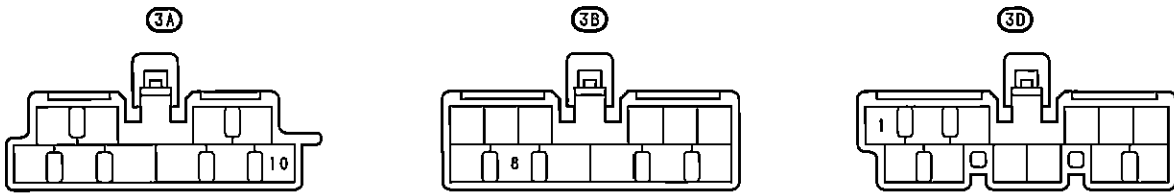
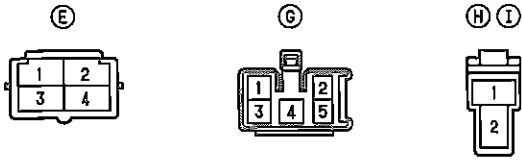
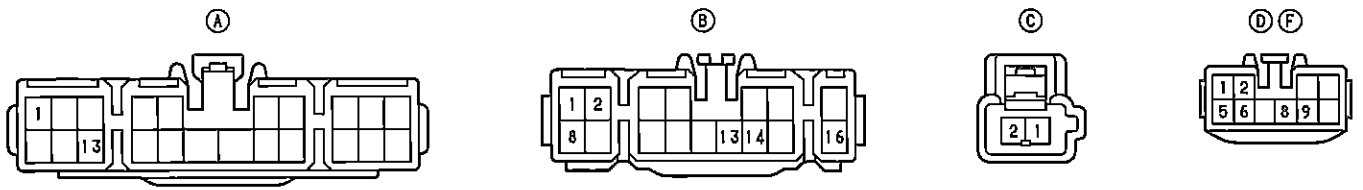



ドアロック

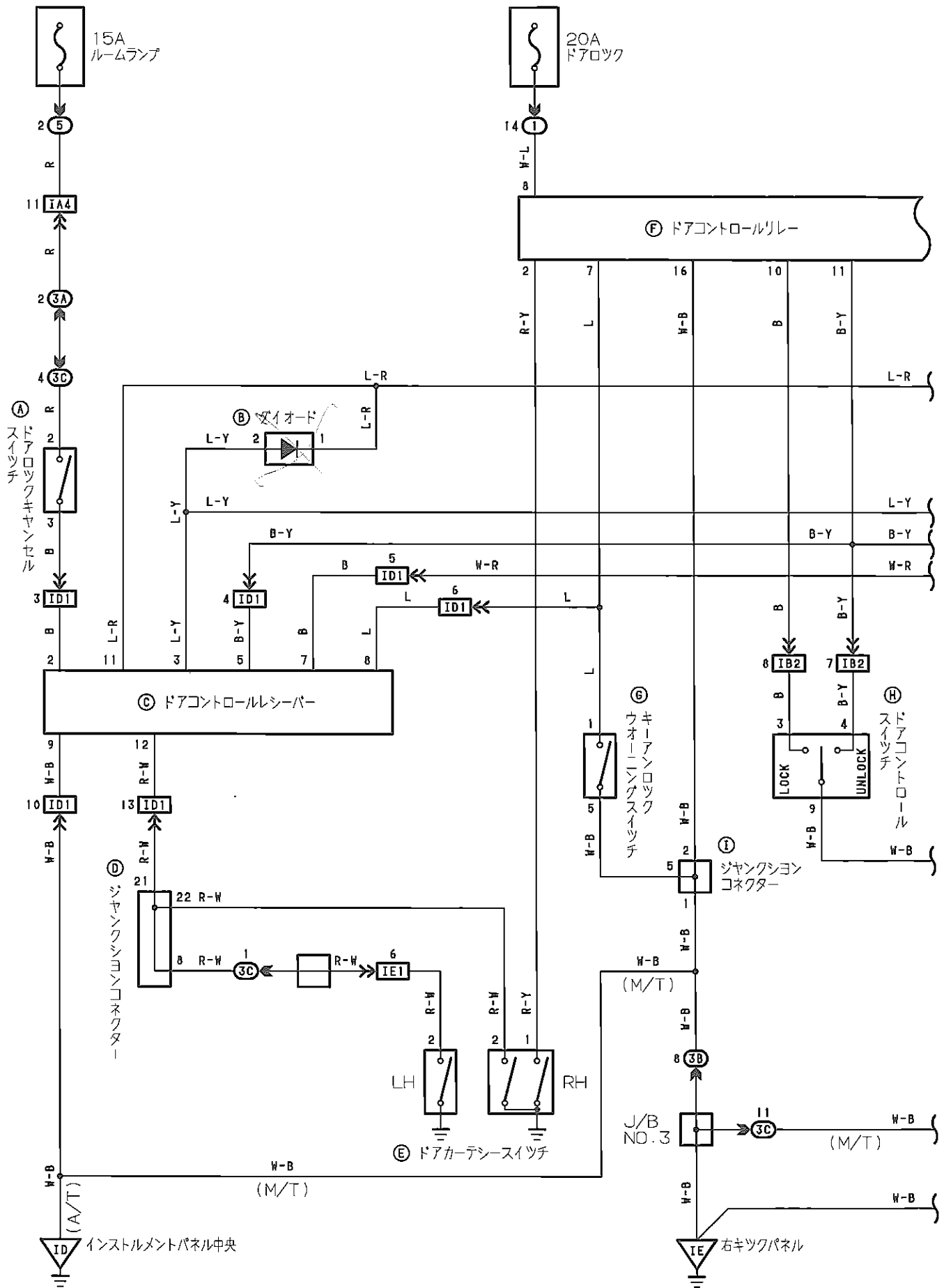

SW OFF

7.5A
メーター
に 60
に 30.

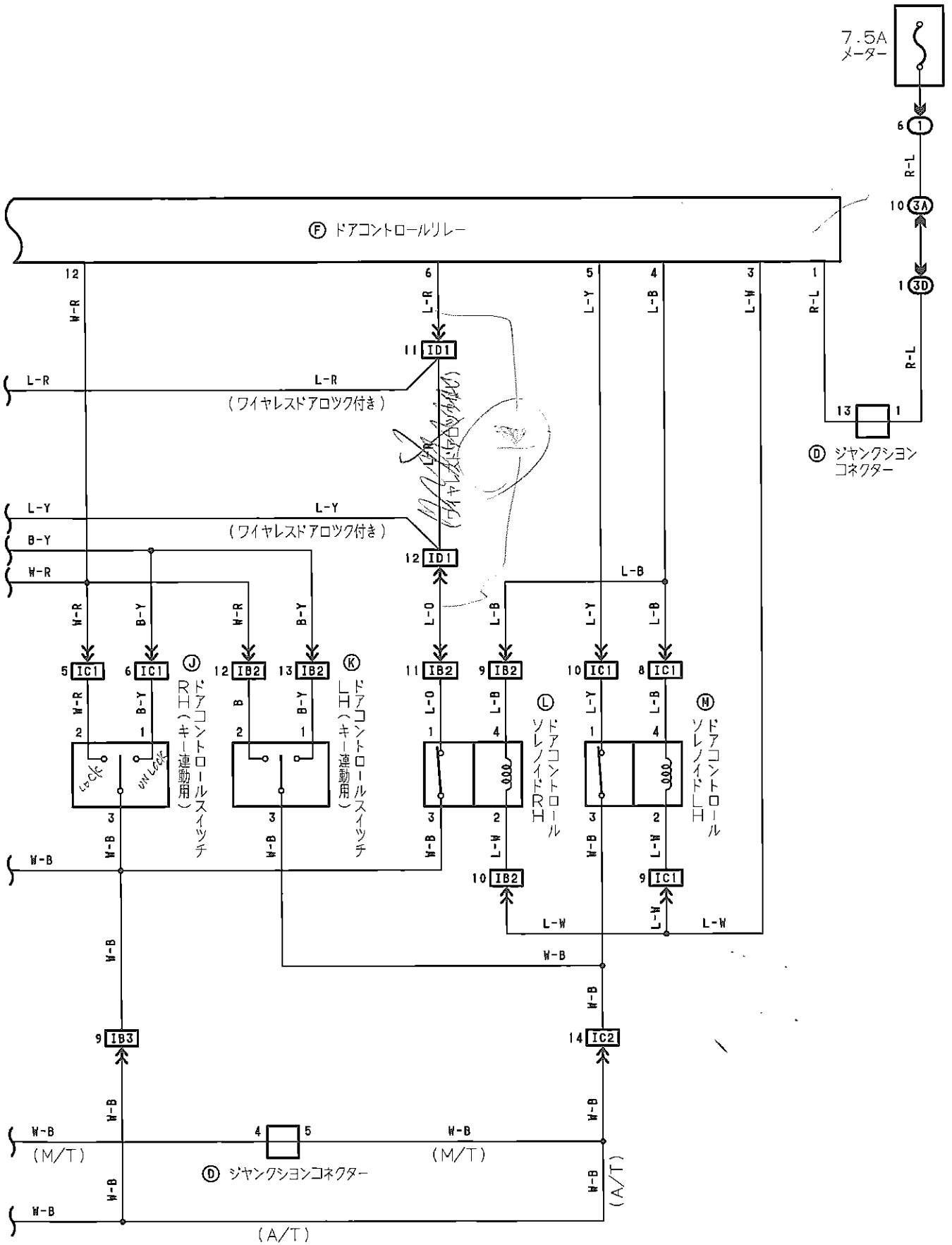



ドアロック

Ⓐ 黒色

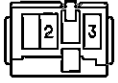

Ⓑ 黒色



Ⓒ



Ⓓ

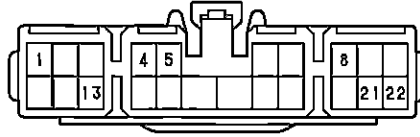

Ⓔ



Ⓕ

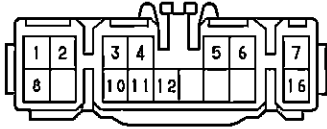

Ⓖ 黒色

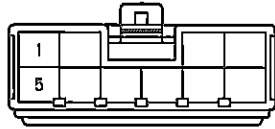

Ⓗ Ⓡ

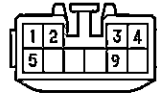

Ⓣ Ⓚ



Ⓛ Ⓜ

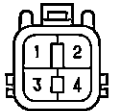

ⓐ

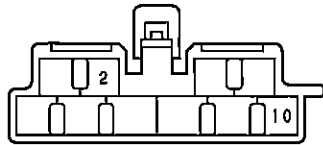

ⓑ

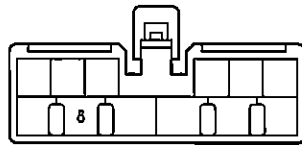

ⓒ

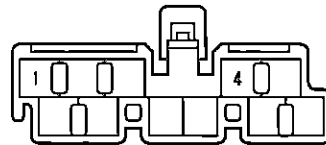

ⓓ

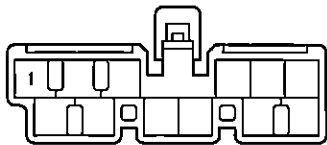

ⓐ ⓑ

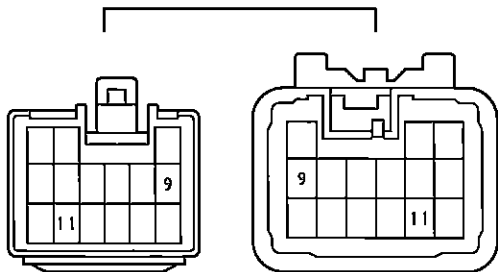

ⓐ ⓑ

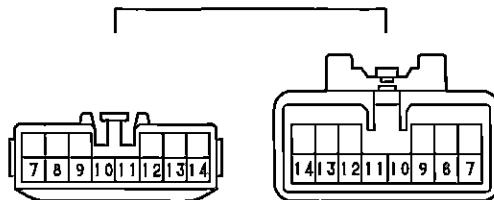

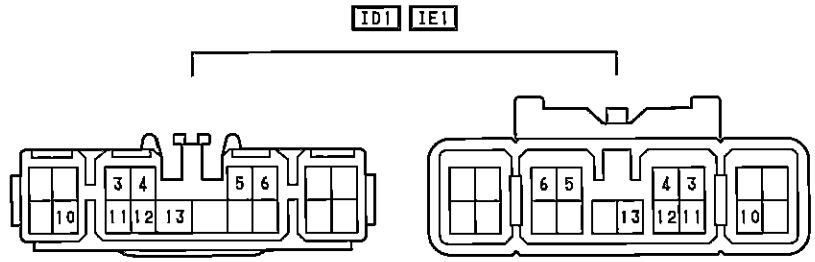
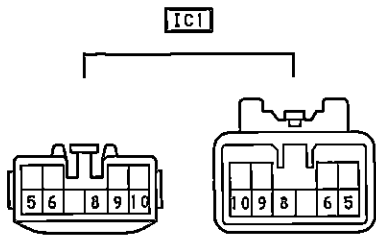

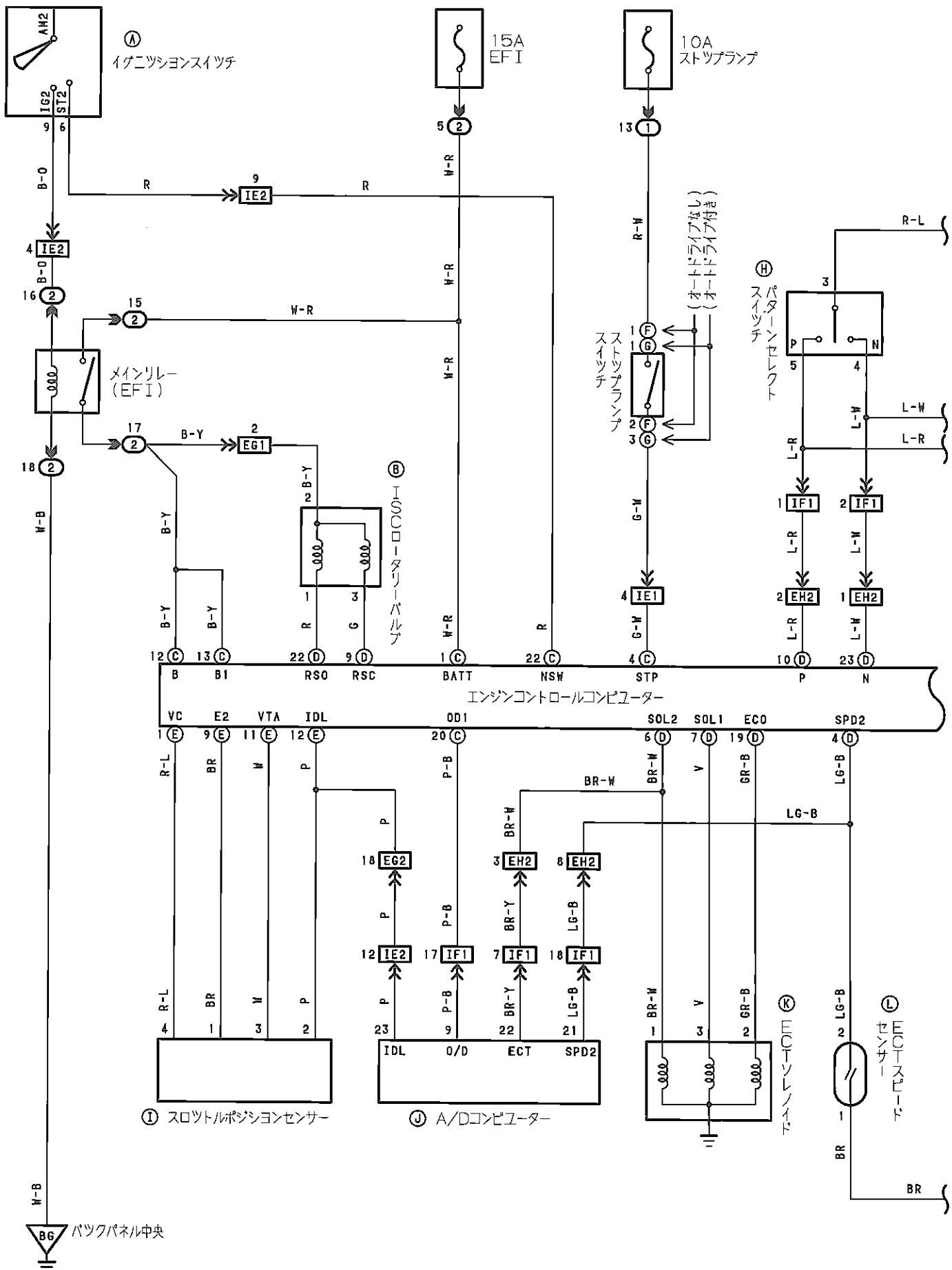

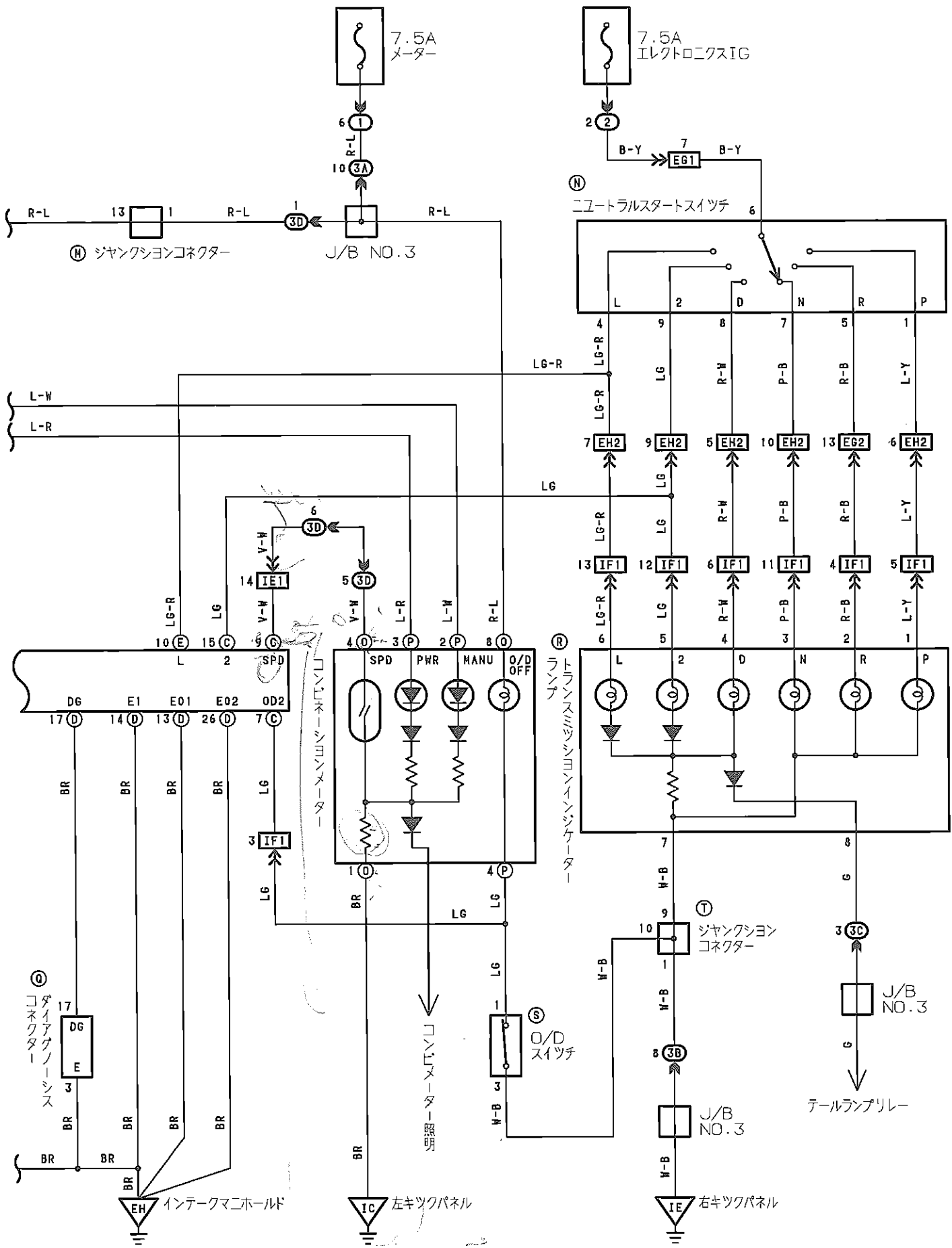

Ⓐ 黒色

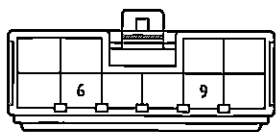

Ⓑ 灰色



Ⓒ 濃灰色

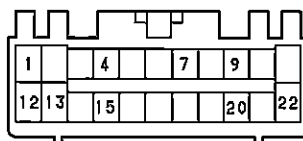

Ⓓ 濃灰色

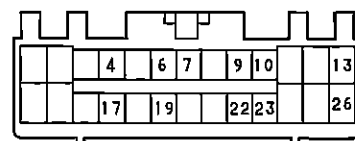

Ⓔ 濃灰色

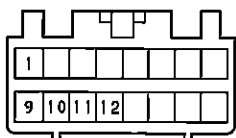

Ⓕ 黒色



Ⓖ



Ⓗ



Ⓘ 黒色



Ⓙ

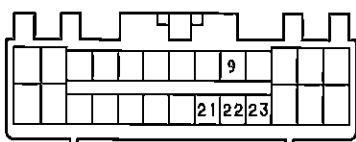

Ⓚ 黒色



Ⓛ 灰色



Ⓜ

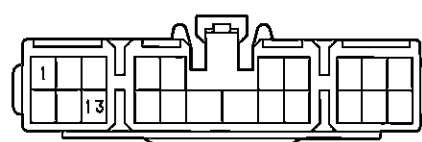

Ⓝ 灰色



Ⓞ

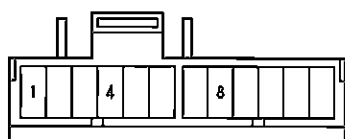

Ⓟ 青色

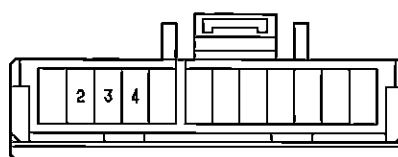

Ⓠ 濃灰色

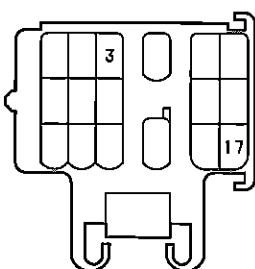

Ⓡ Ⓣ

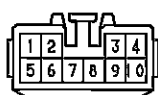

Ⓢ



3A

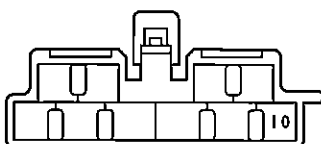

3B

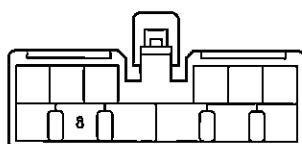

3C

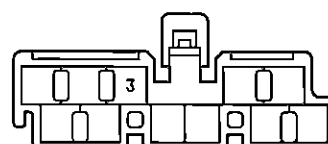

3D

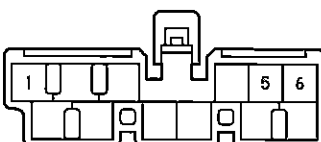

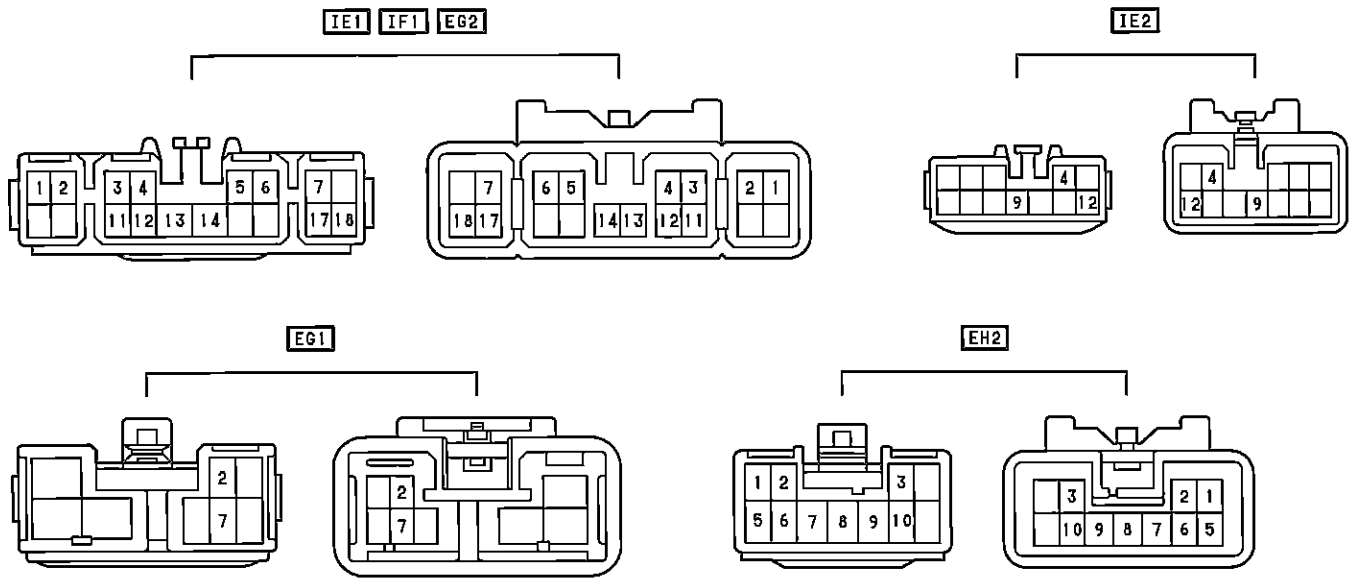

ABS

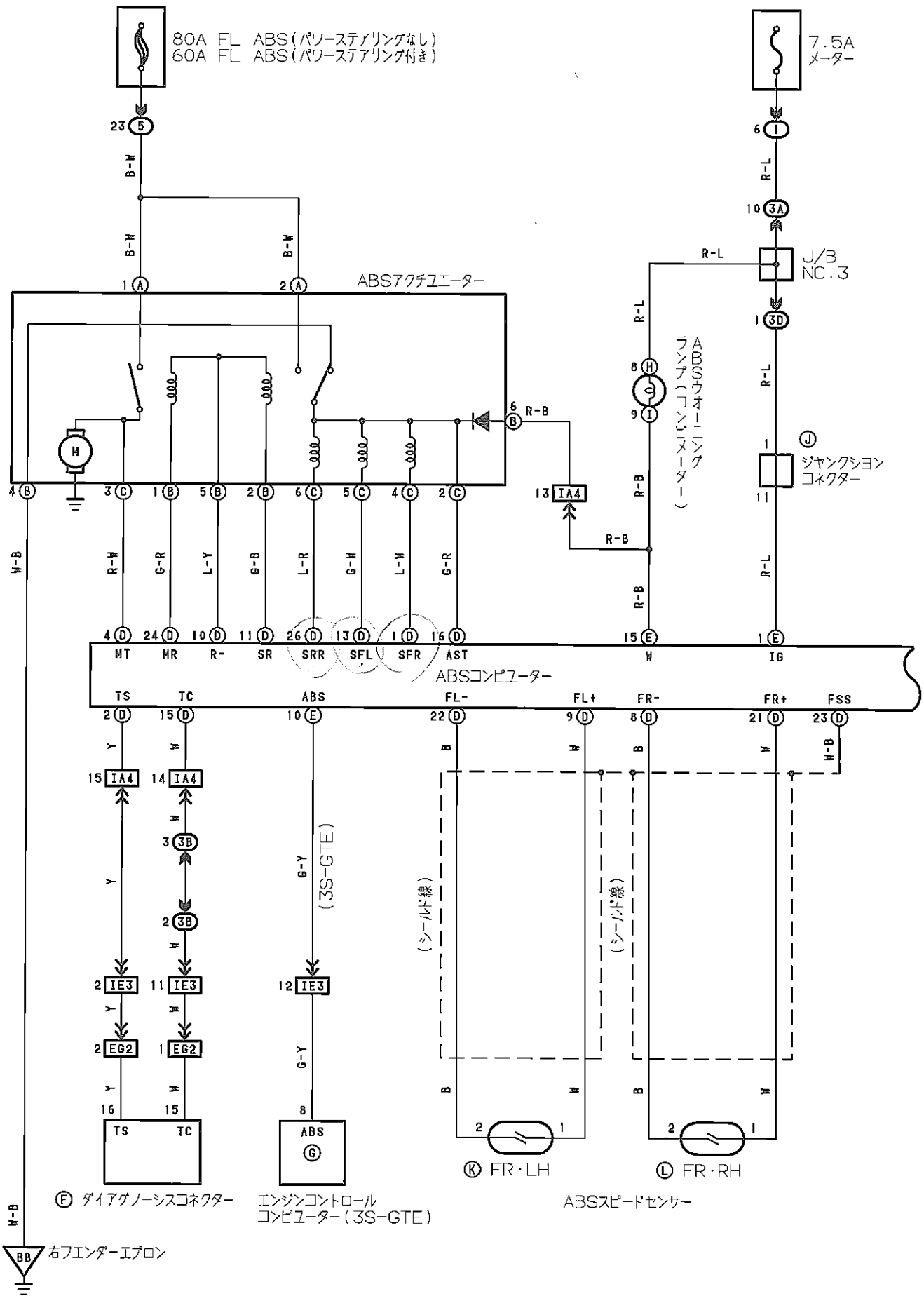

⑤ ダイアグノースコネクタ
 インジコンコントロール
 コンピューター (3S-GTE)

ABSスピードセンサー

右フエンダー-エプロン

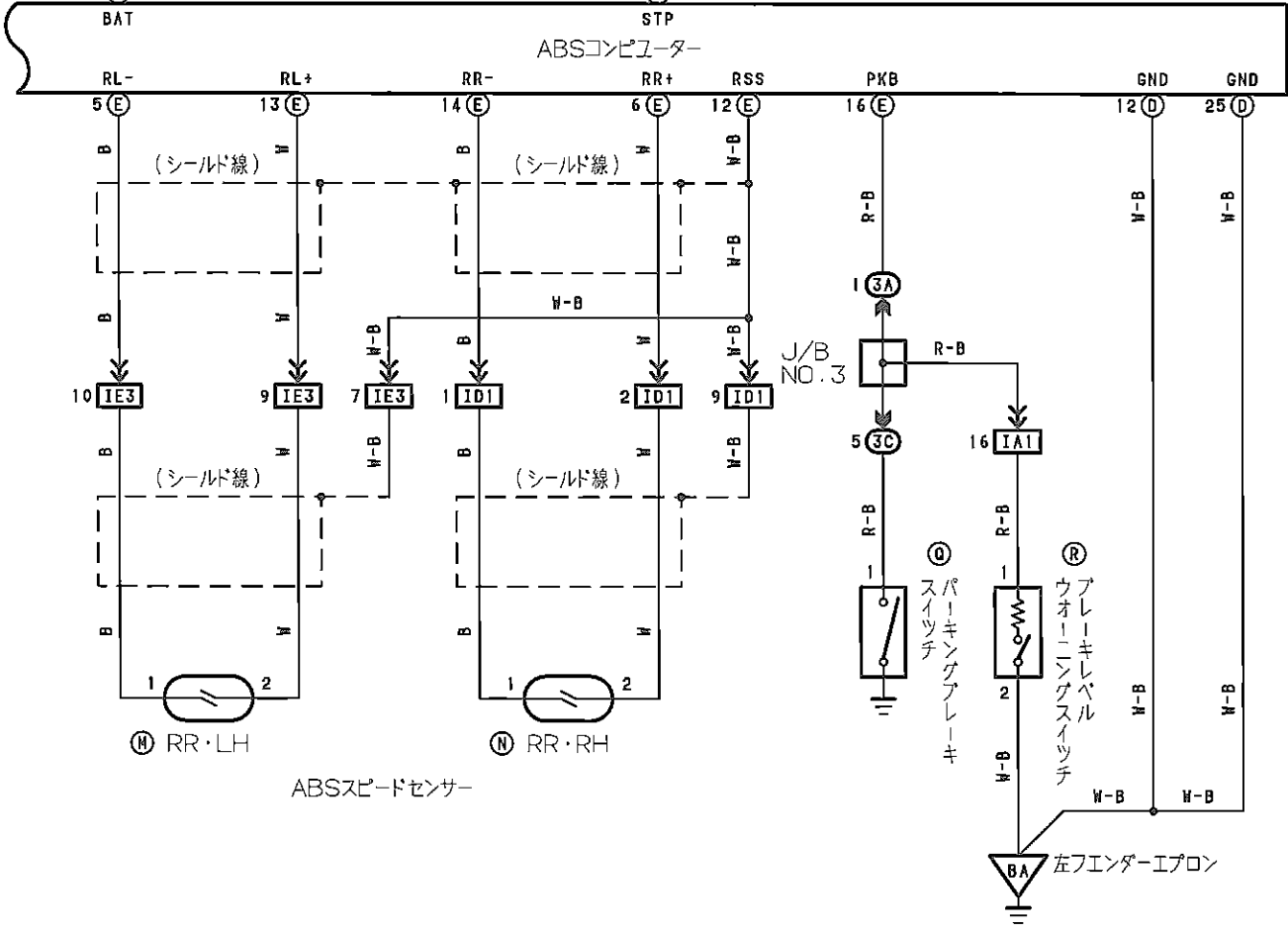
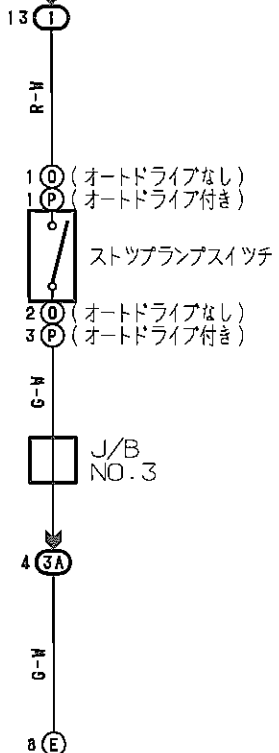
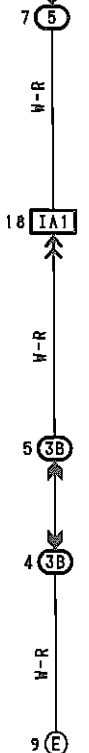
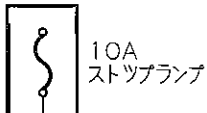
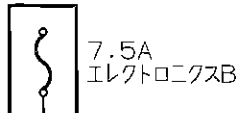



ABS

Ⓐ 灰色



Ⓑ 灰色

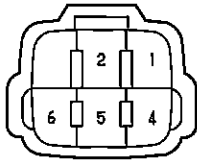

Ⓒ 灰色

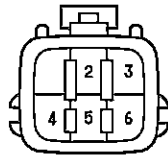

Ⓓ 濃灰色

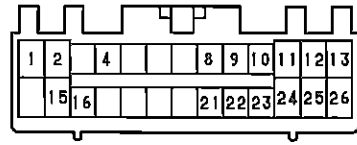

Ⓔ 濃灰色

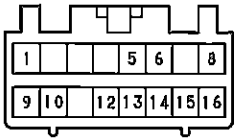

Ⓕ 濃灰色

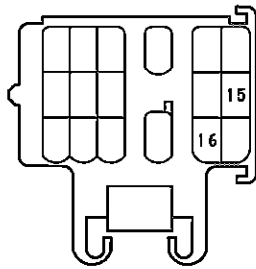

Ⓖ 濃灰色

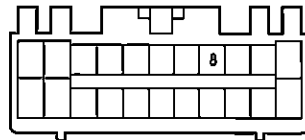

Ⓕ

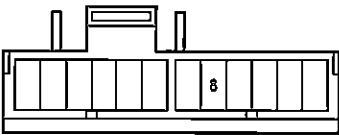

Ⓖ 灰色

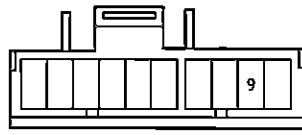

Ⓙ

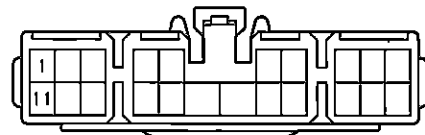

Ⓚ Ⓛ 灰色



Ⓜ Ⓝ 灰色



Ⓞ 黑色

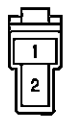

Ⓟ



Ⓠ 黑色



Ⓡ 灰色

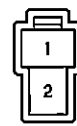

3A

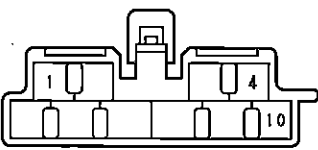

3B

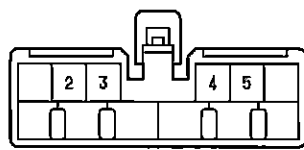

3C

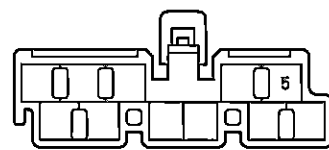

3D

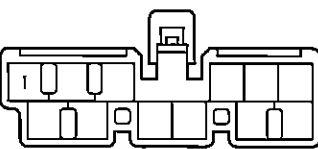

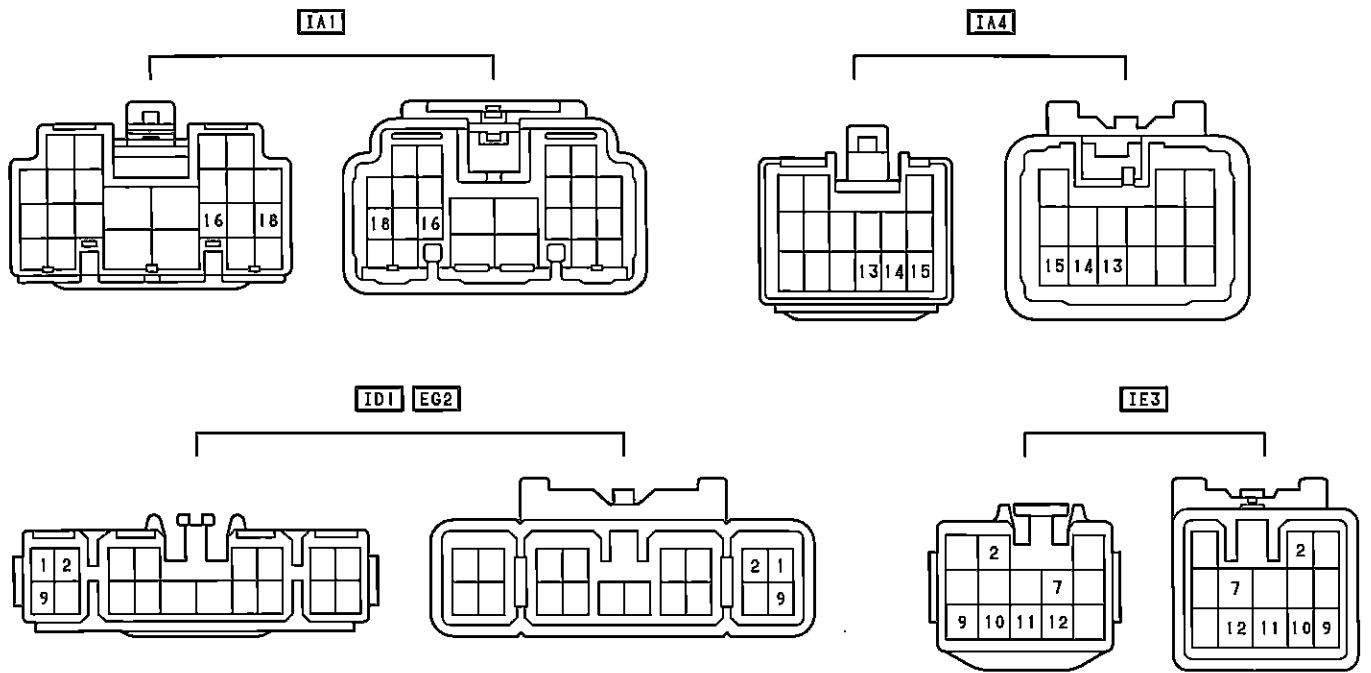

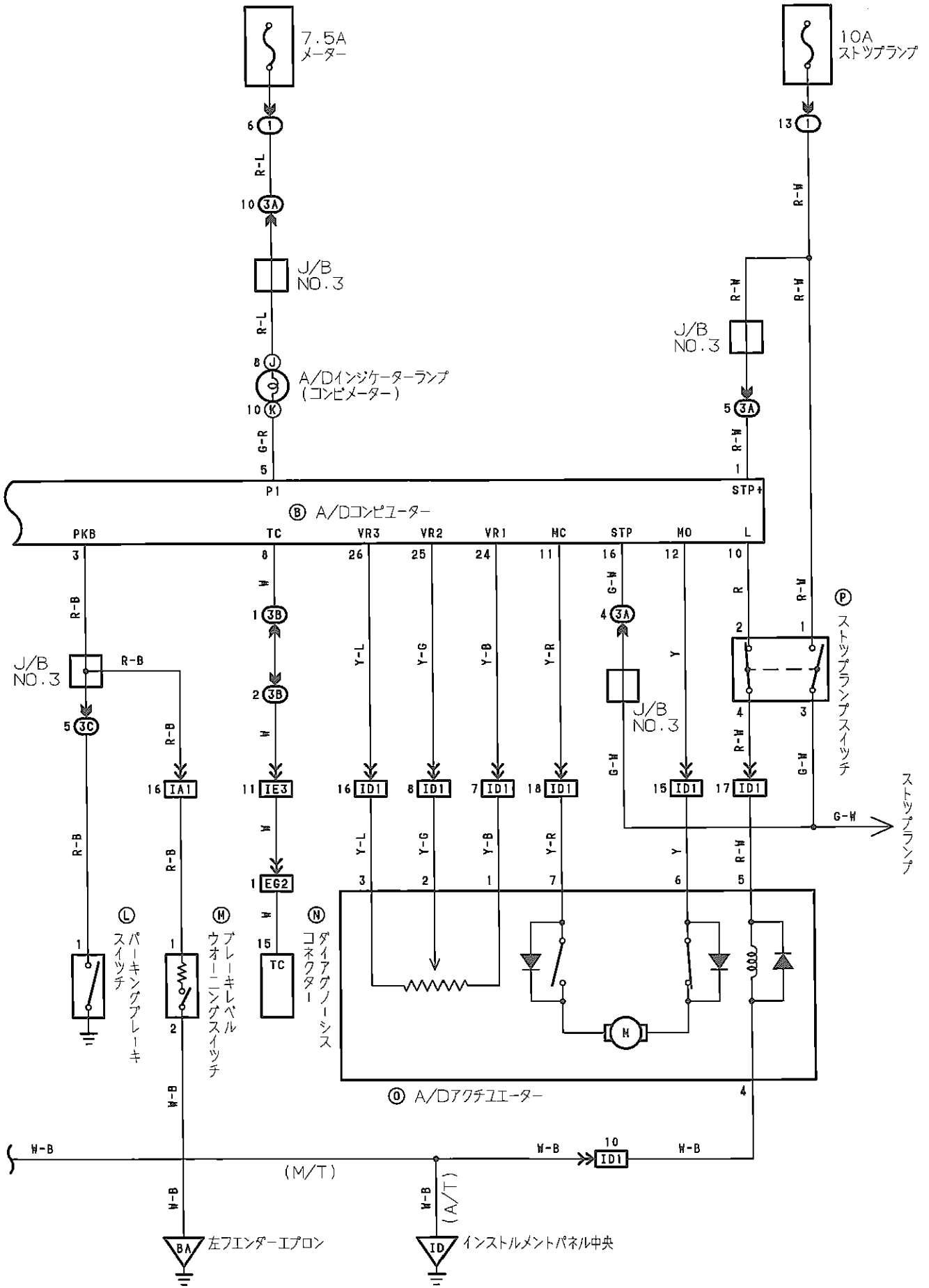



オートドライブ

Ⓐ 黒色

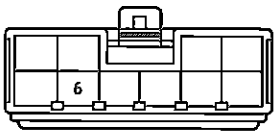

Ⓑ

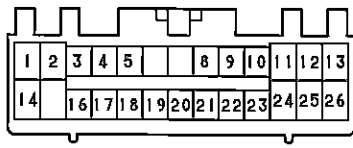

Ⓒ 濃灰色

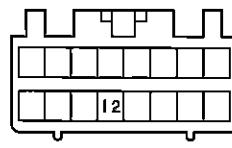

Ⓓ 濃灰色

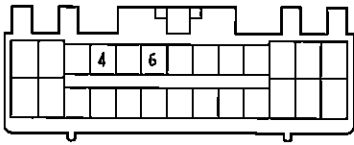

Ⓔ 濃灰色

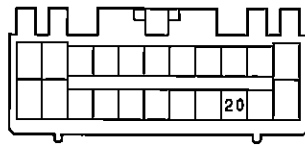

Ⓕ



Ⓖ 黒色

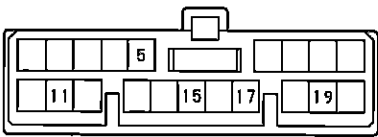

Ⓖ

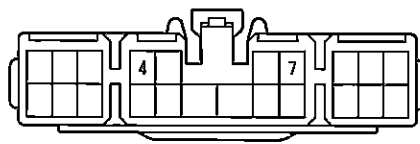

Ⓗ

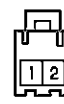

Ⓙ

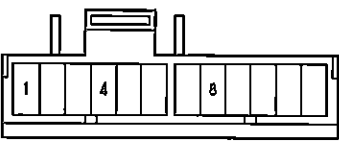

Ⓚ 青色

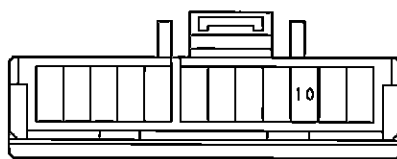

Ⓛ



Ⓜ



Ⓝ 濃灰色

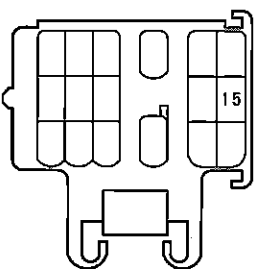

Ⓞ 灰色

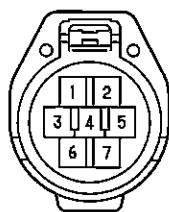

Ⓟ



3A

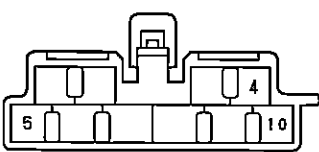

3B

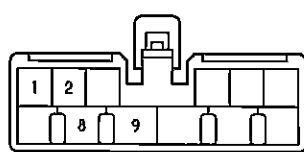

3C

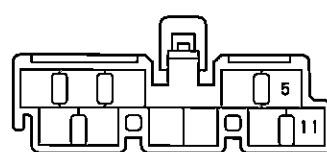

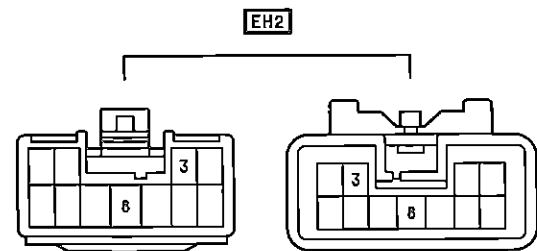
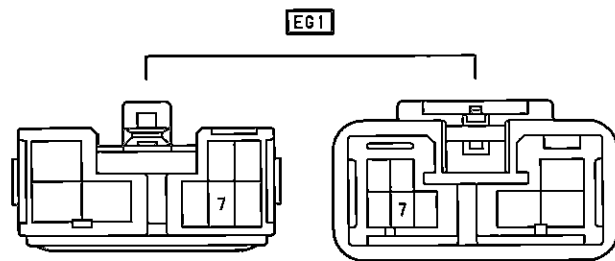
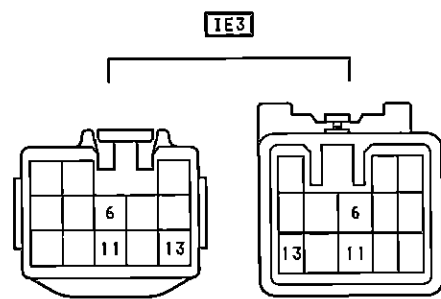
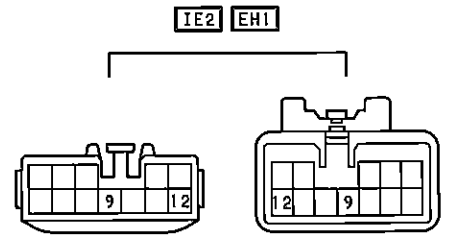
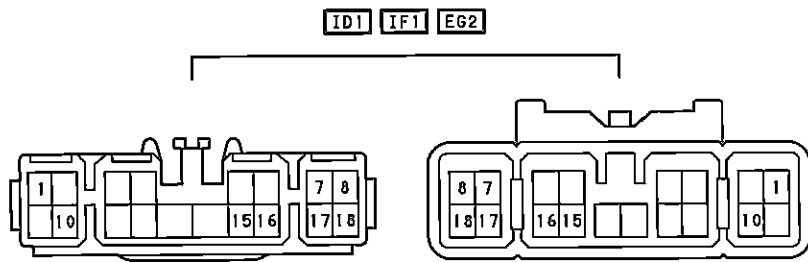
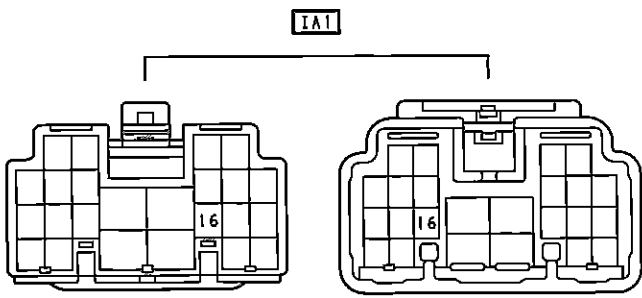



シフトロックシステム

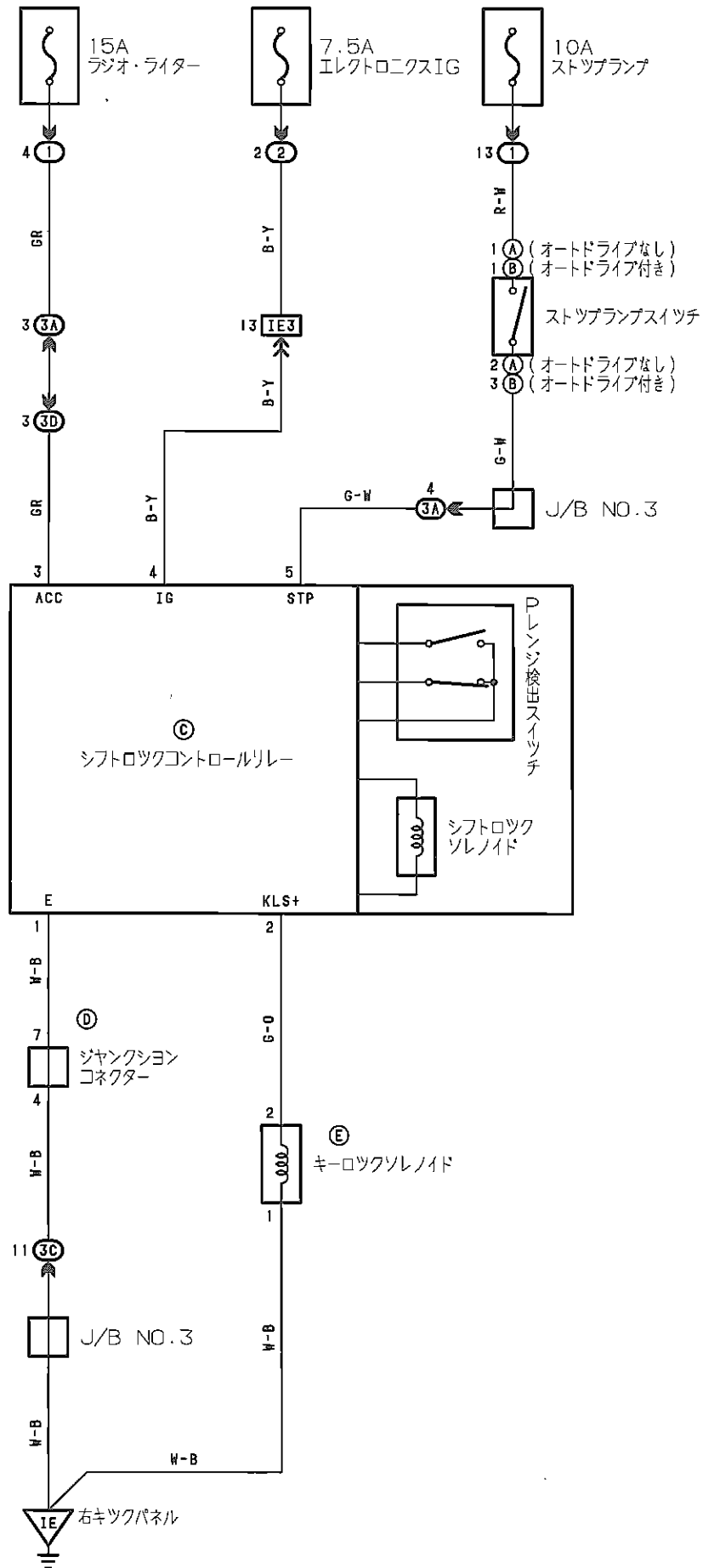

Ⓐ 黒色



Ⓑ



Ⓒ



Ⓓ

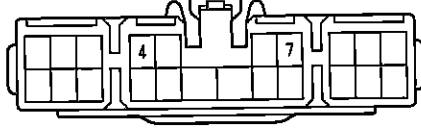

Ⓔ 青色

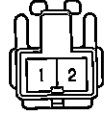

ⒸA

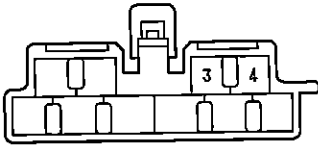

ⒸB

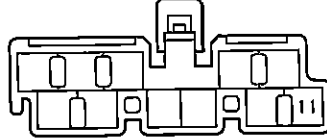

ⒸC

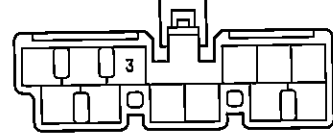

IE3

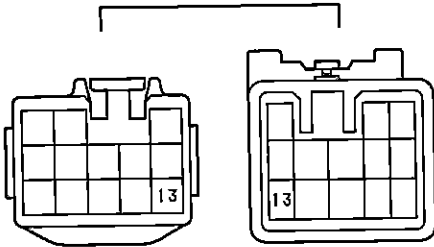



ホーン

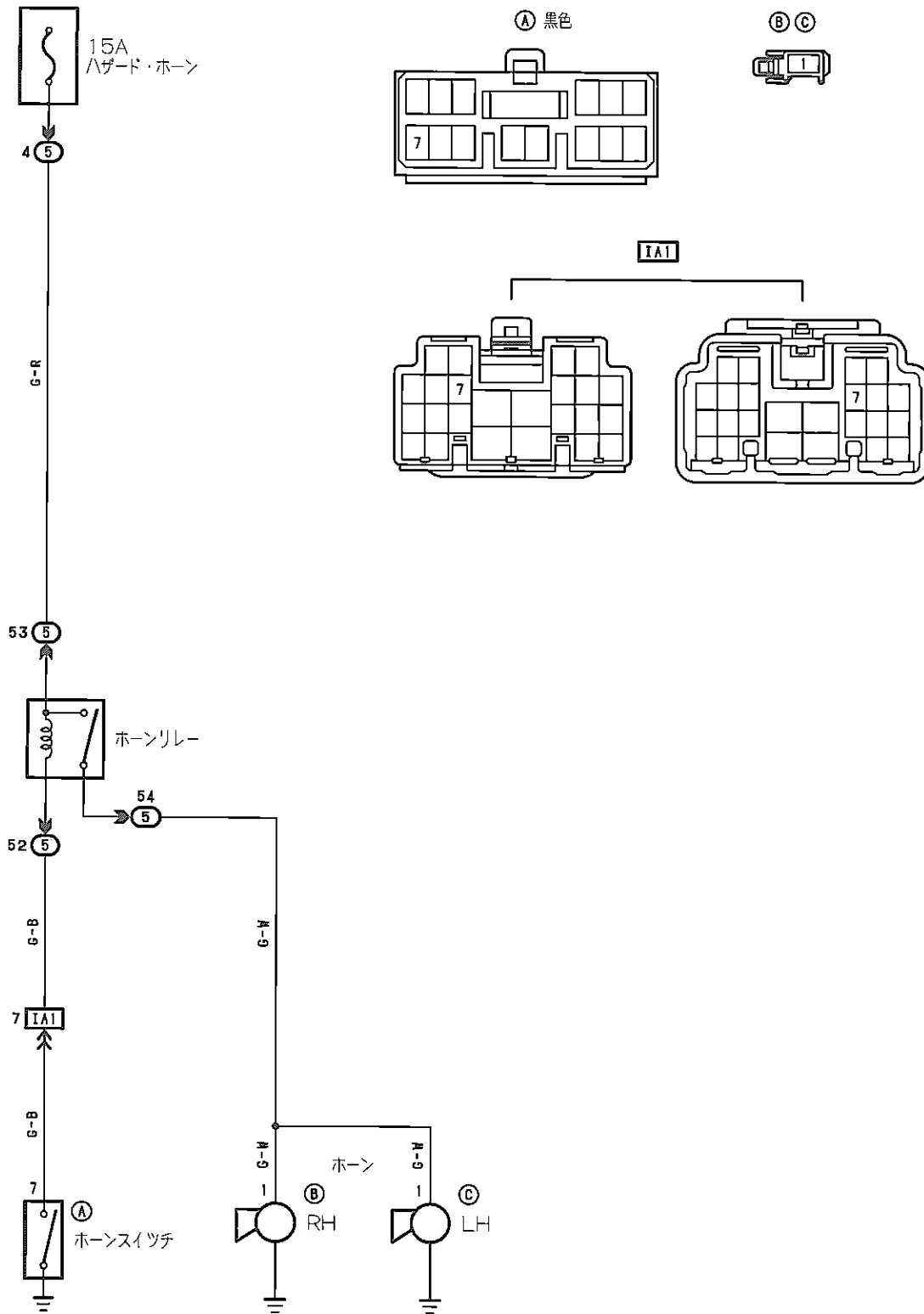

シガレットライター & クロツク

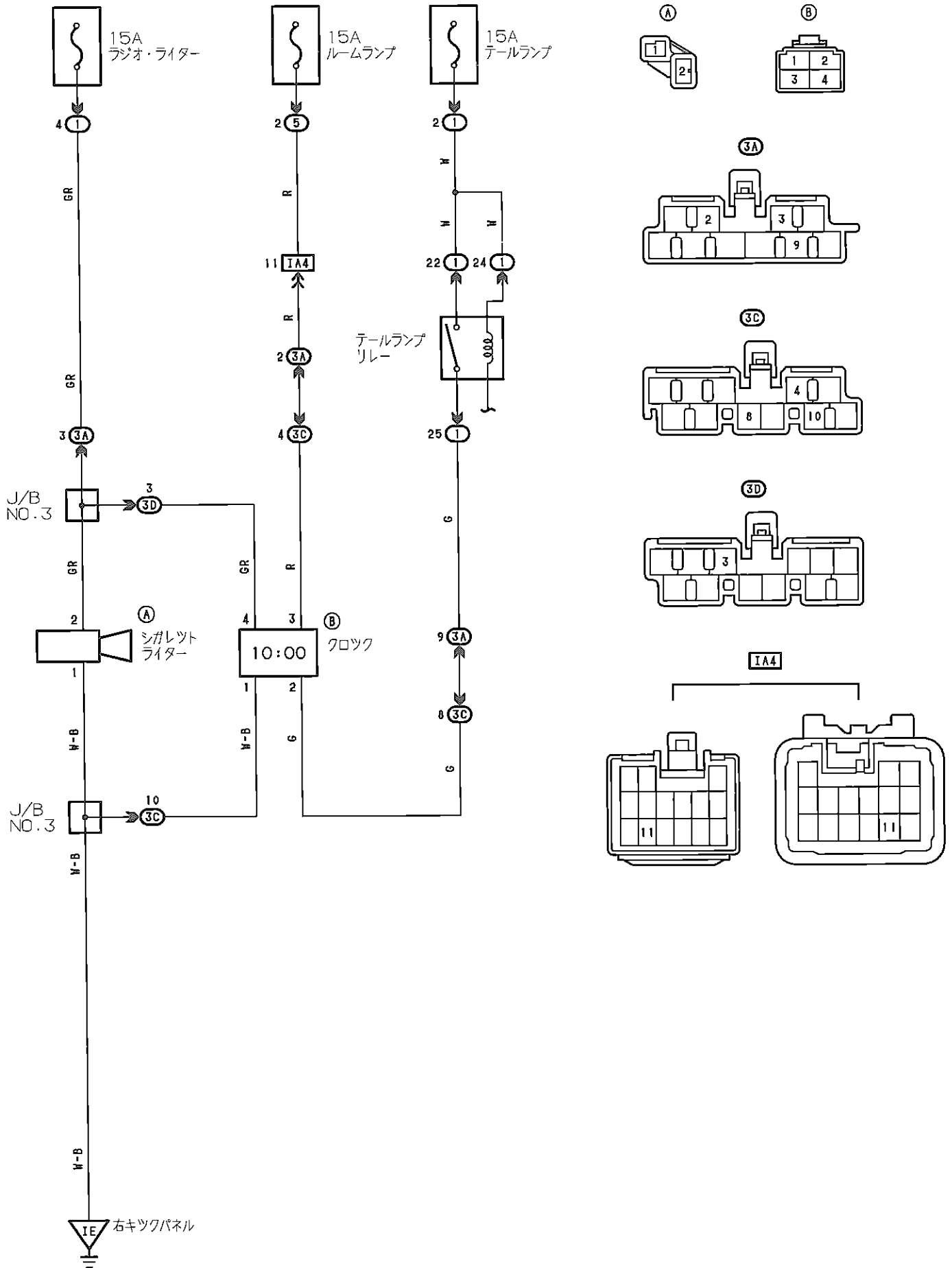



ラジオ & ステレオ (CD又はDATなし)

(ラジオのみ)

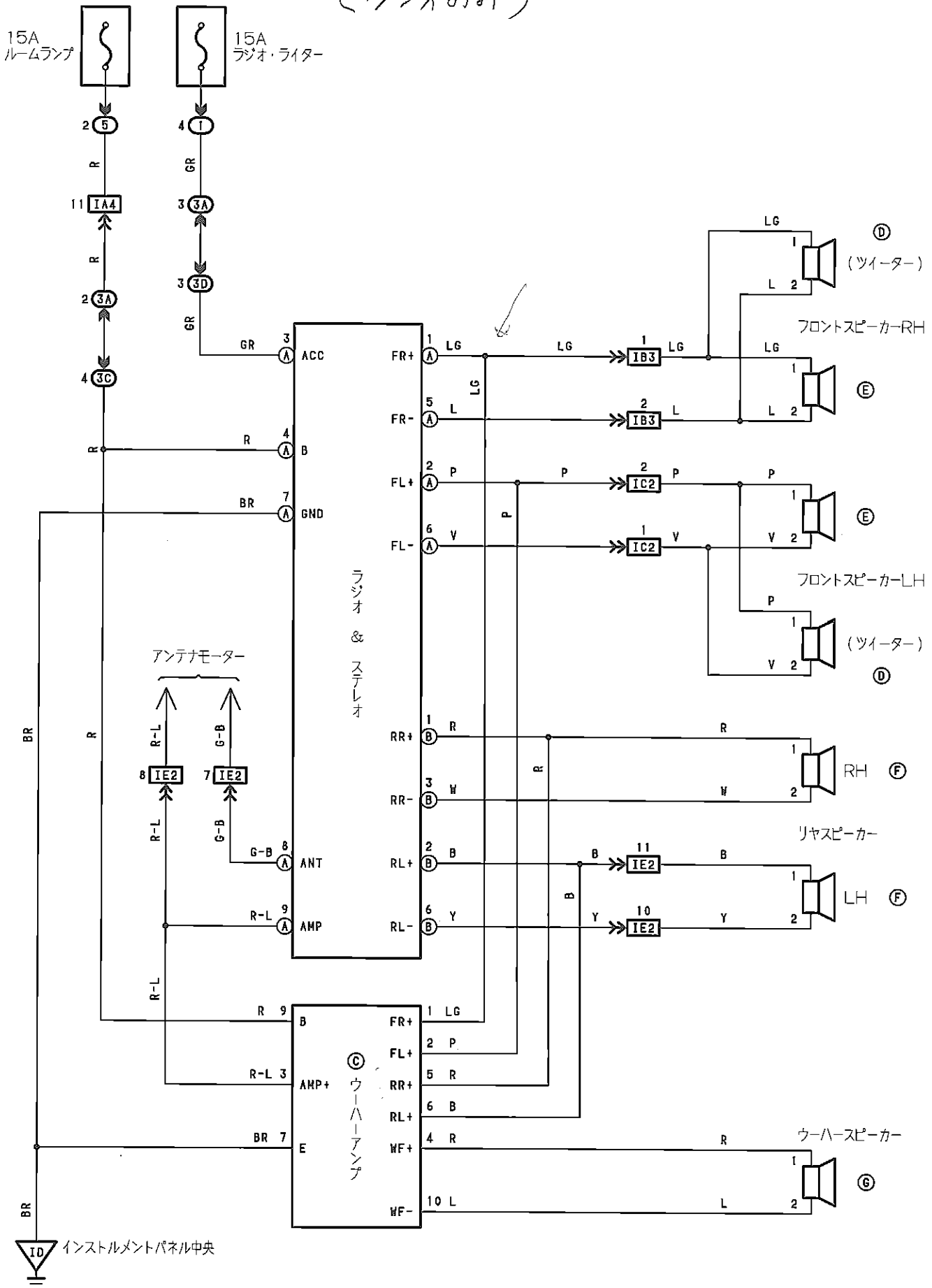

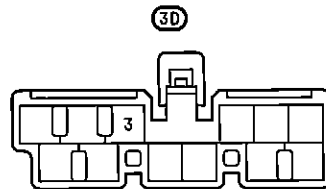
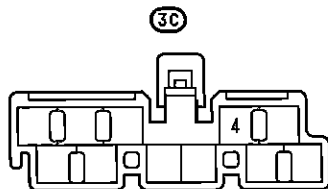
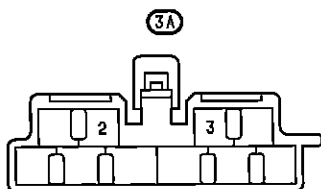
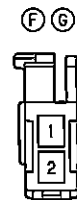
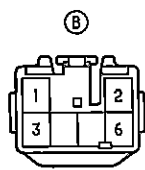
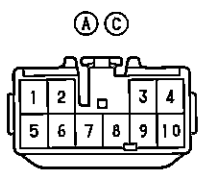

IA4 IB3

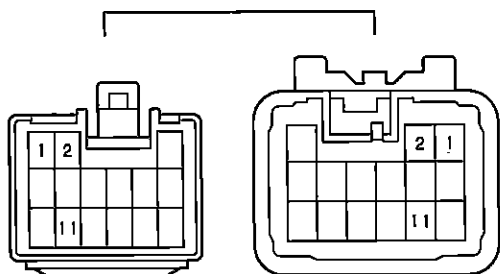

IC2

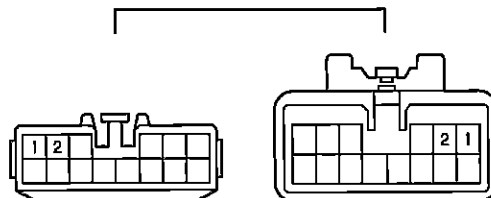

IE2

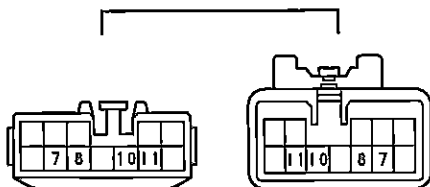



ラジオ & ステレオ (~~CDXはDAT付~~)

(マウント, CP)

15A
ラジオ・ライター

15A
ルームランプ

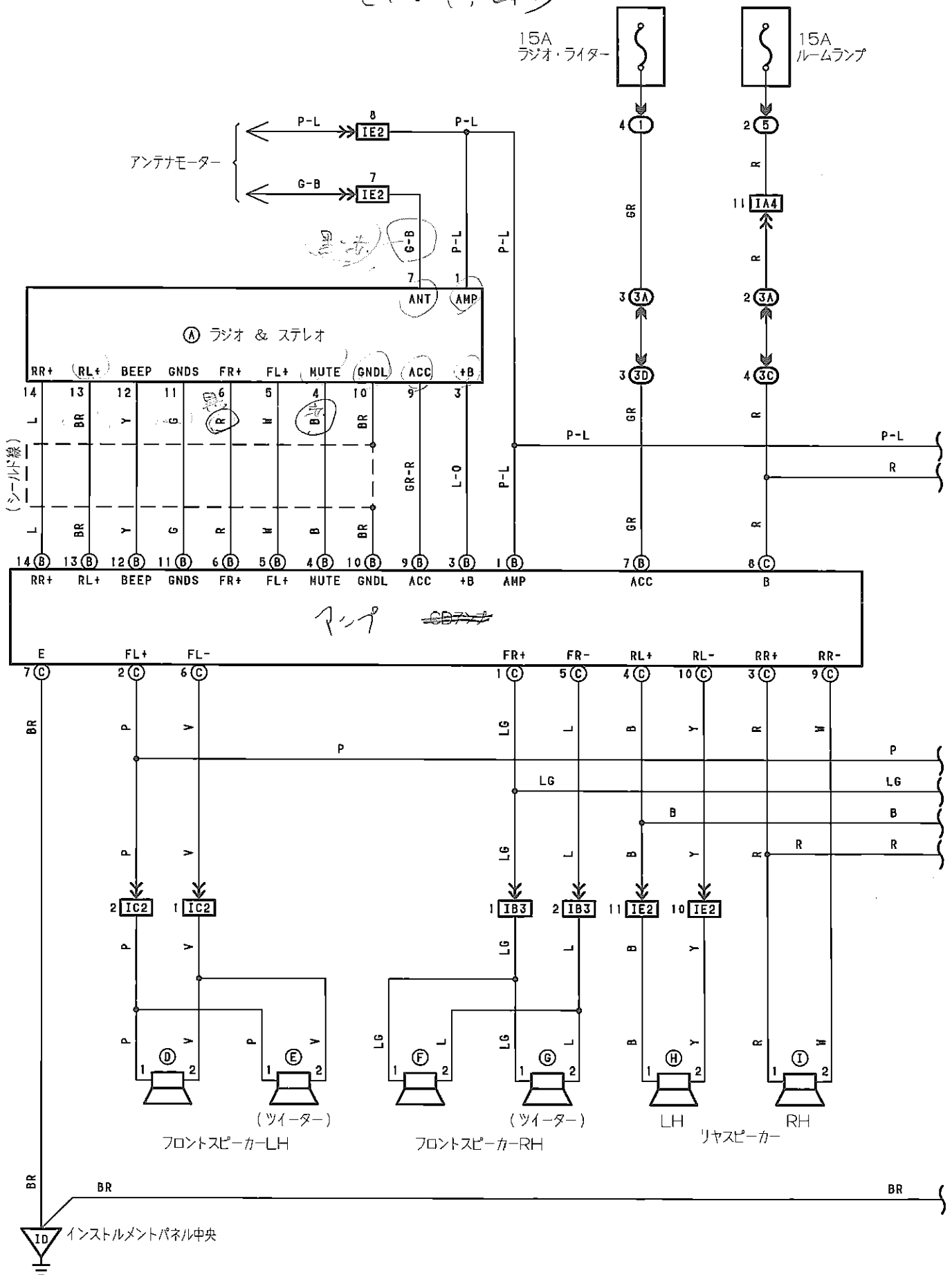

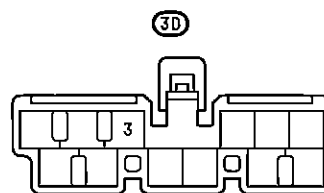
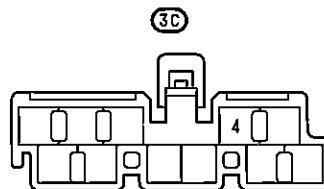
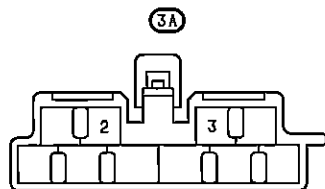
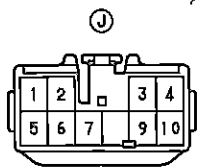
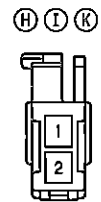
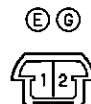
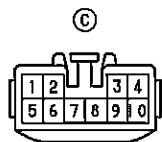
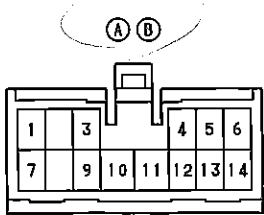

IA4 IB3

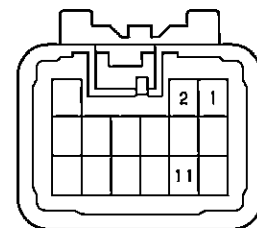
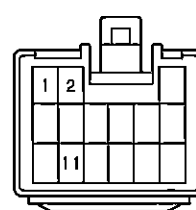

IC2

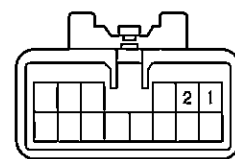
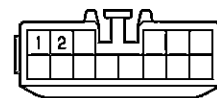

IE2

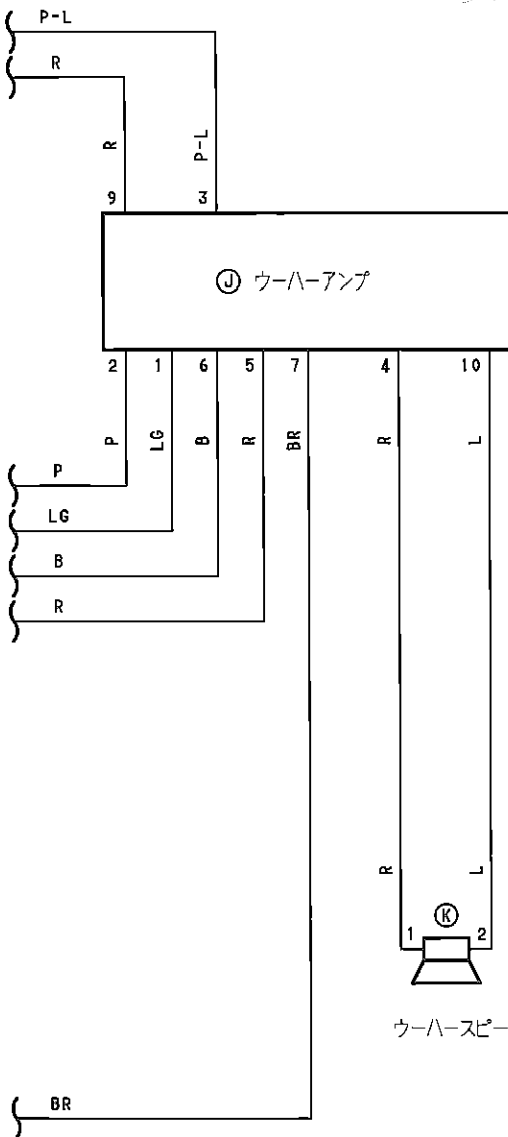
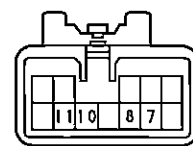
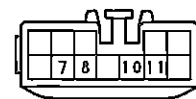

7-10
C+ 7-10



アンテナモーター

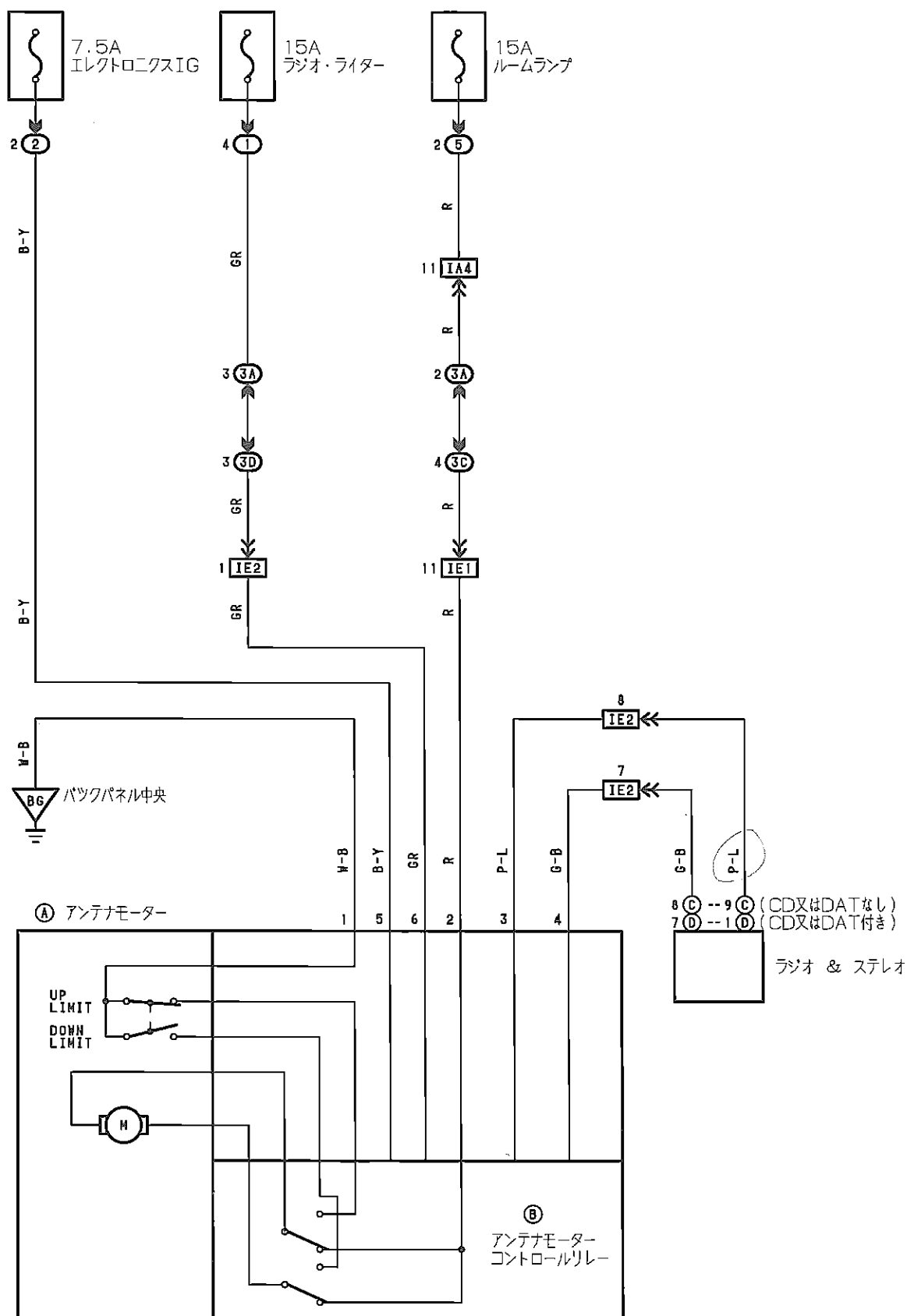

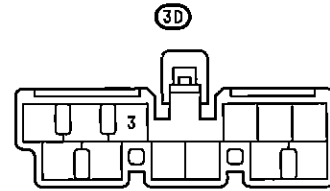
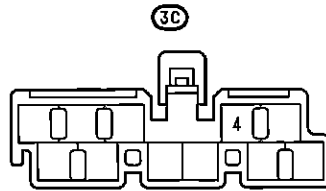
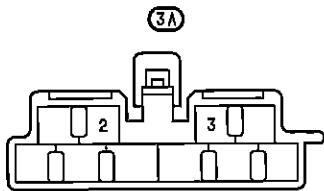
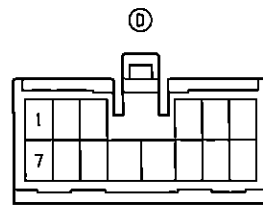
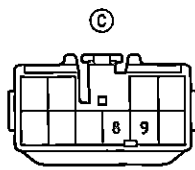
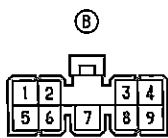
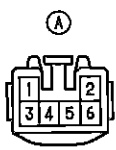

IA4

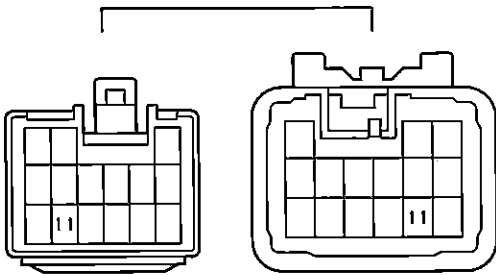

IE1

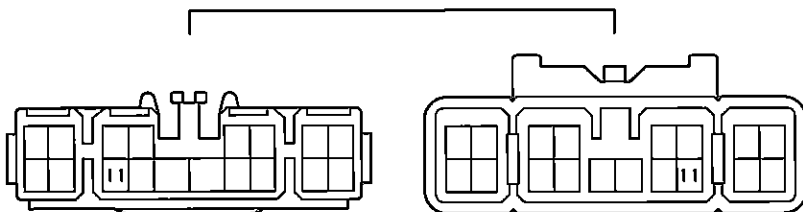

IE2

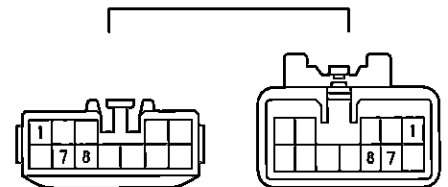



コンビネーションメーター

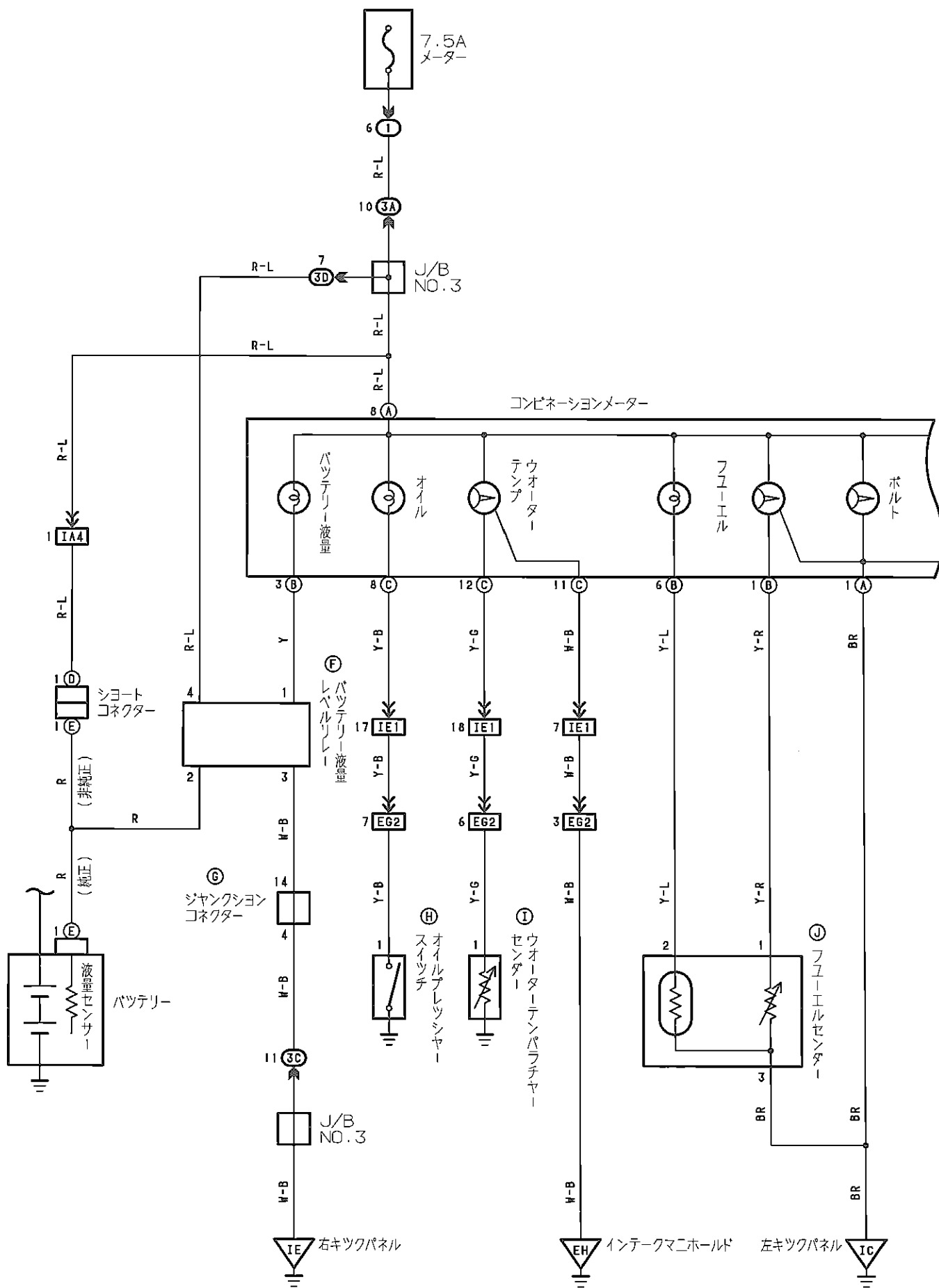

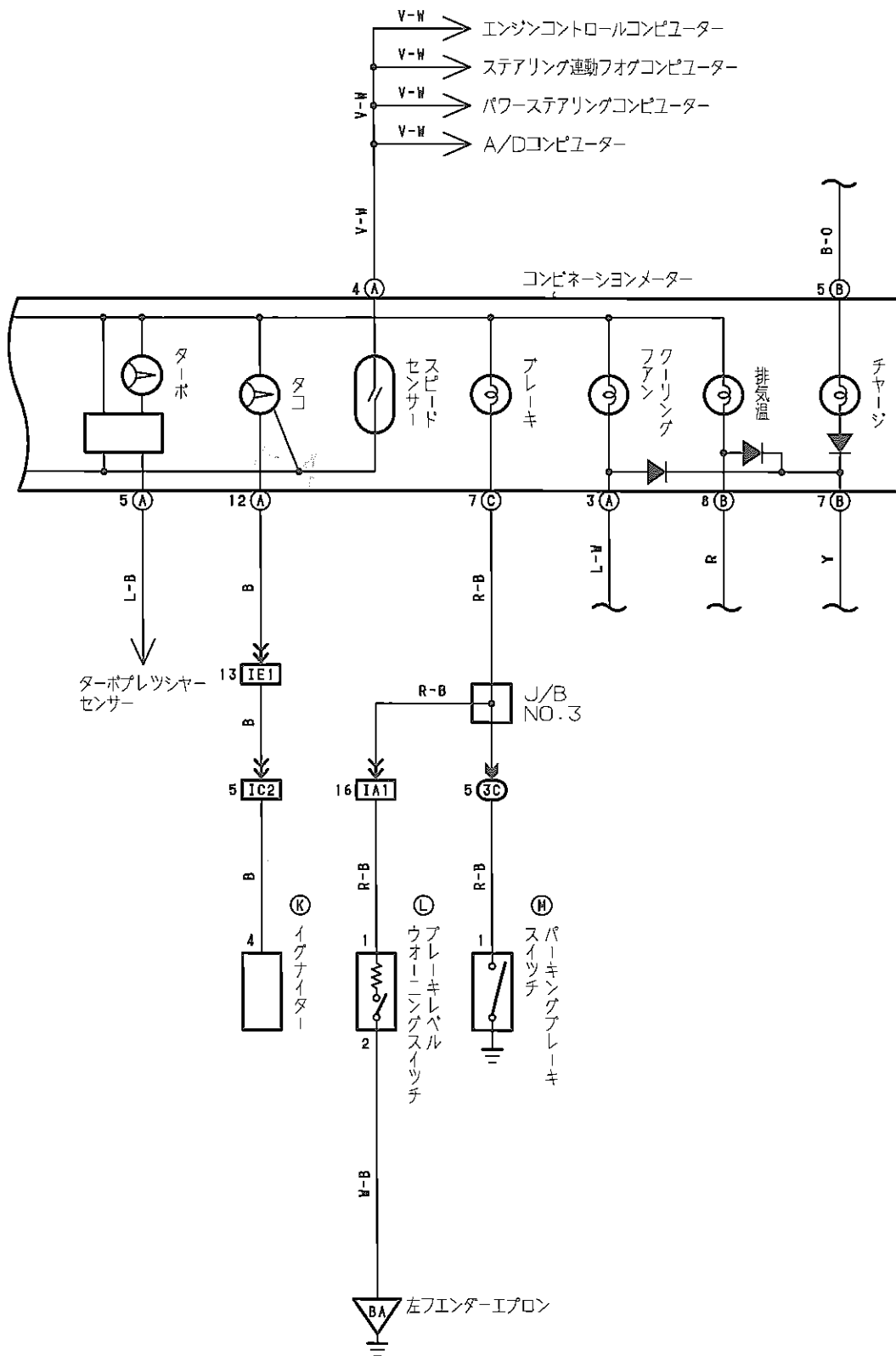

コンビネーションメーター

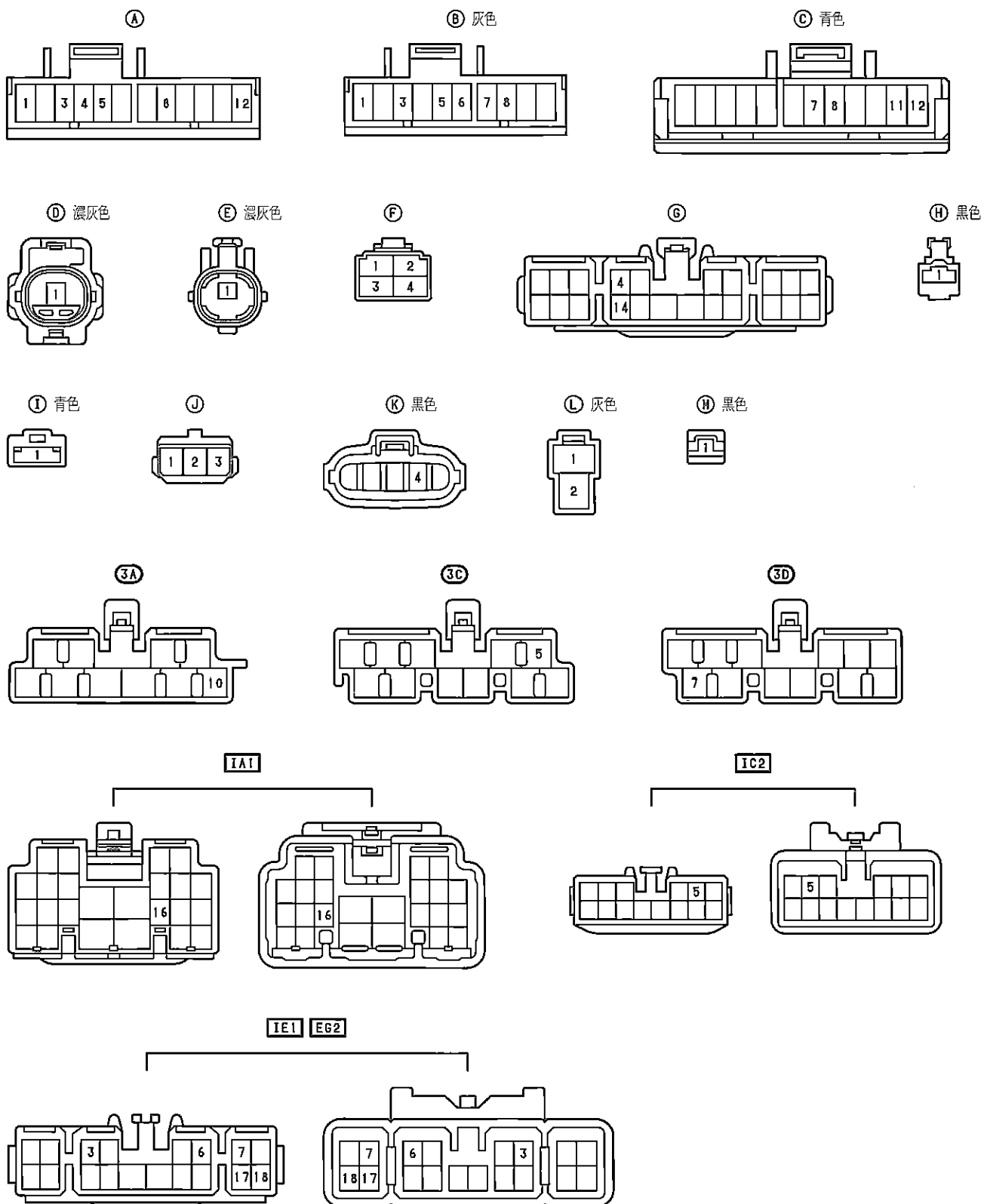

ラジエーターファン(エアコン付き) & オートエアコンデিশヨナー

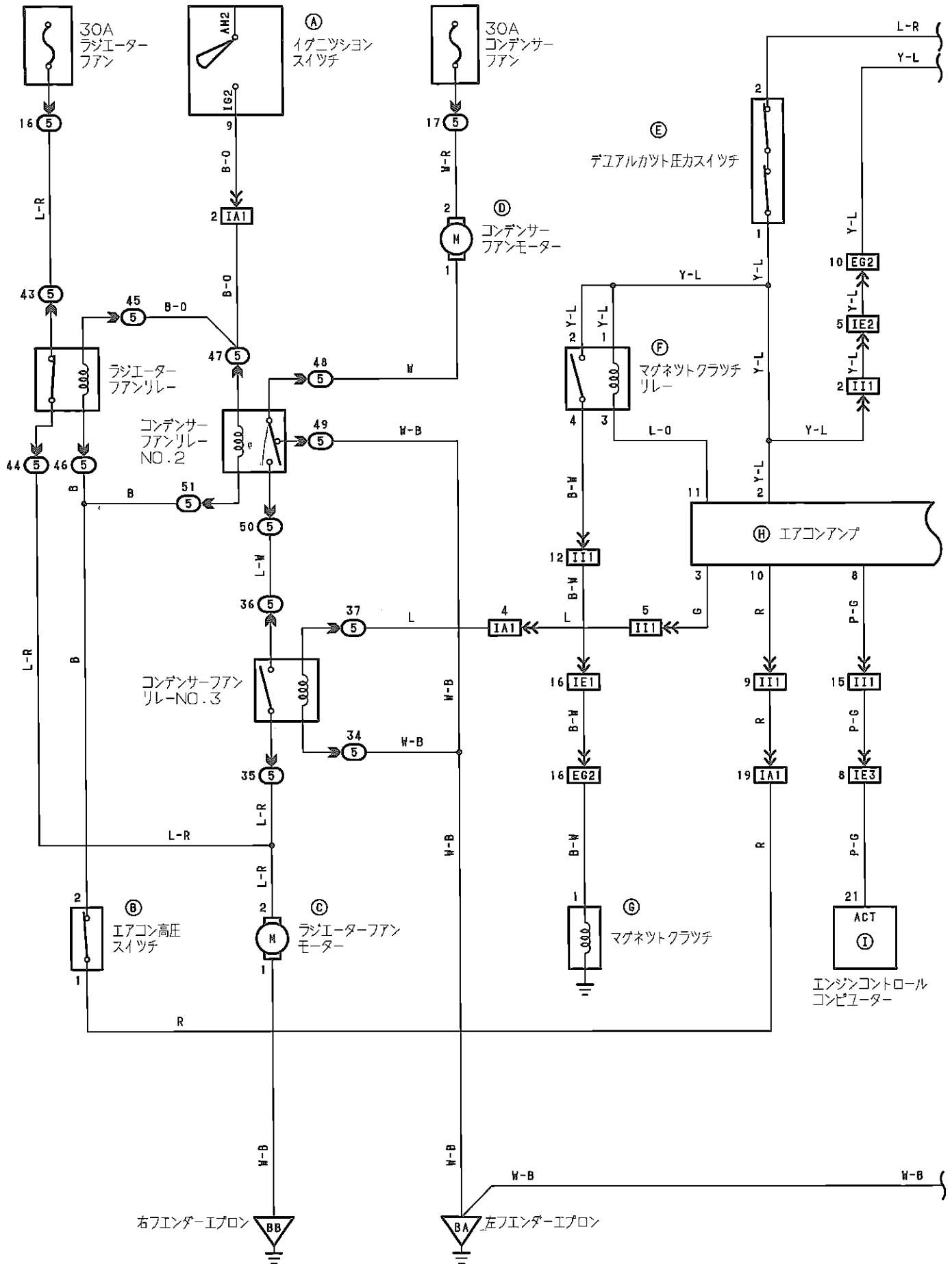



ラジエーターファン(エアコン付き) & オートエアコンデyshoナー

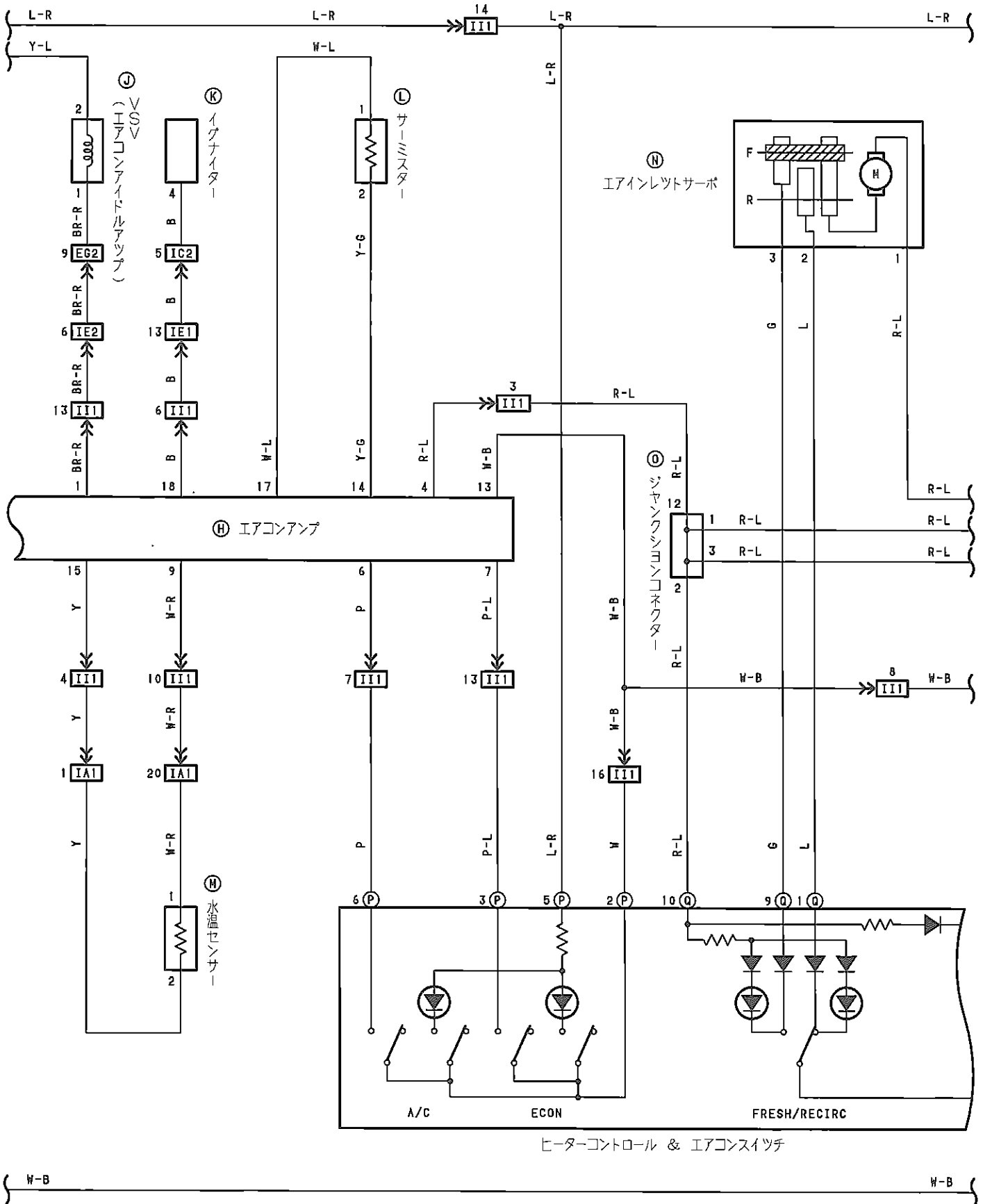

L-R L-R

モードコントロールサーボ

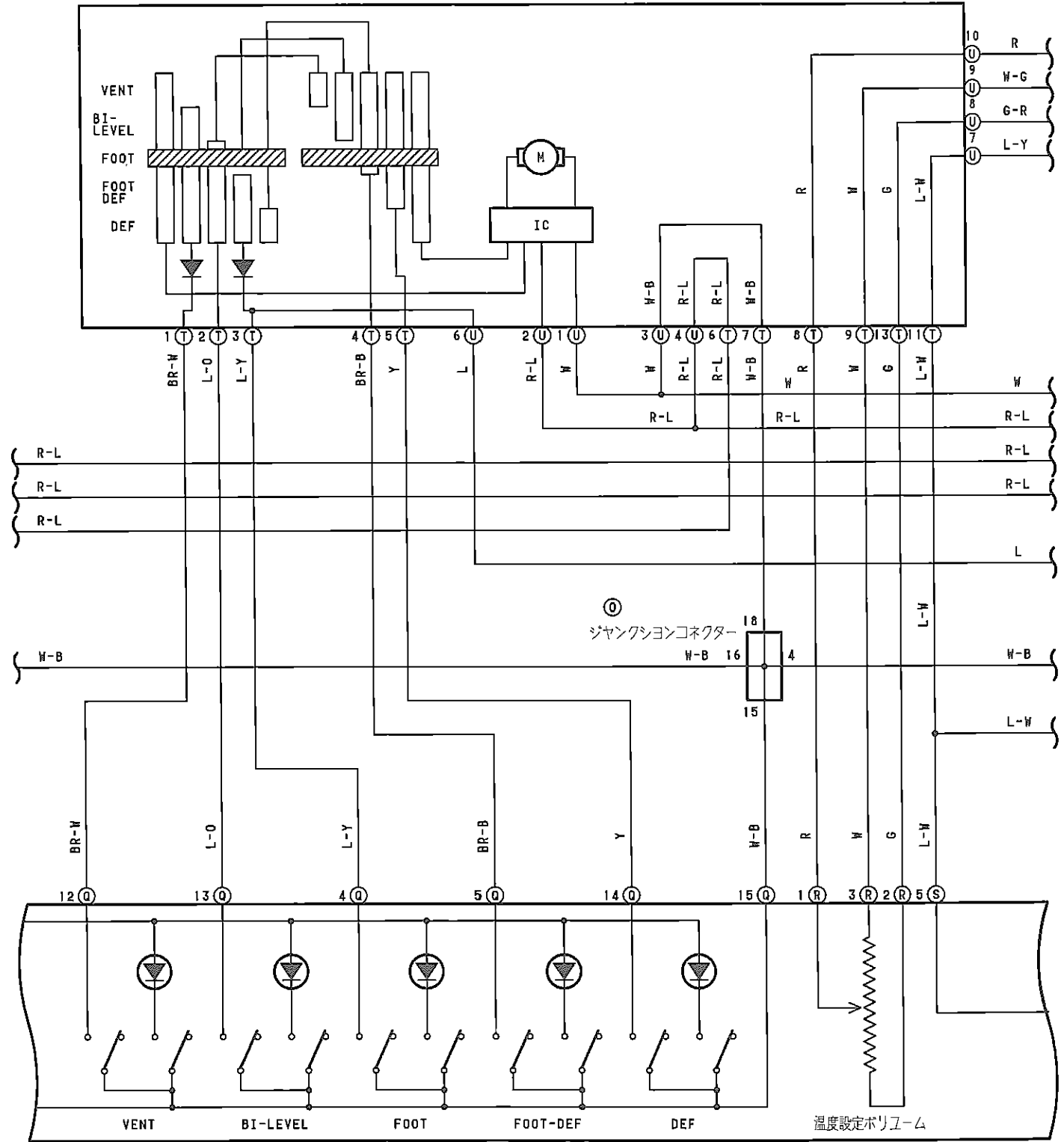

ヒーターコントロール & エアコンスイッチ

W-B W-B



ラジエーターファン(エアコン付き) & オートエアコンデিশヨナー

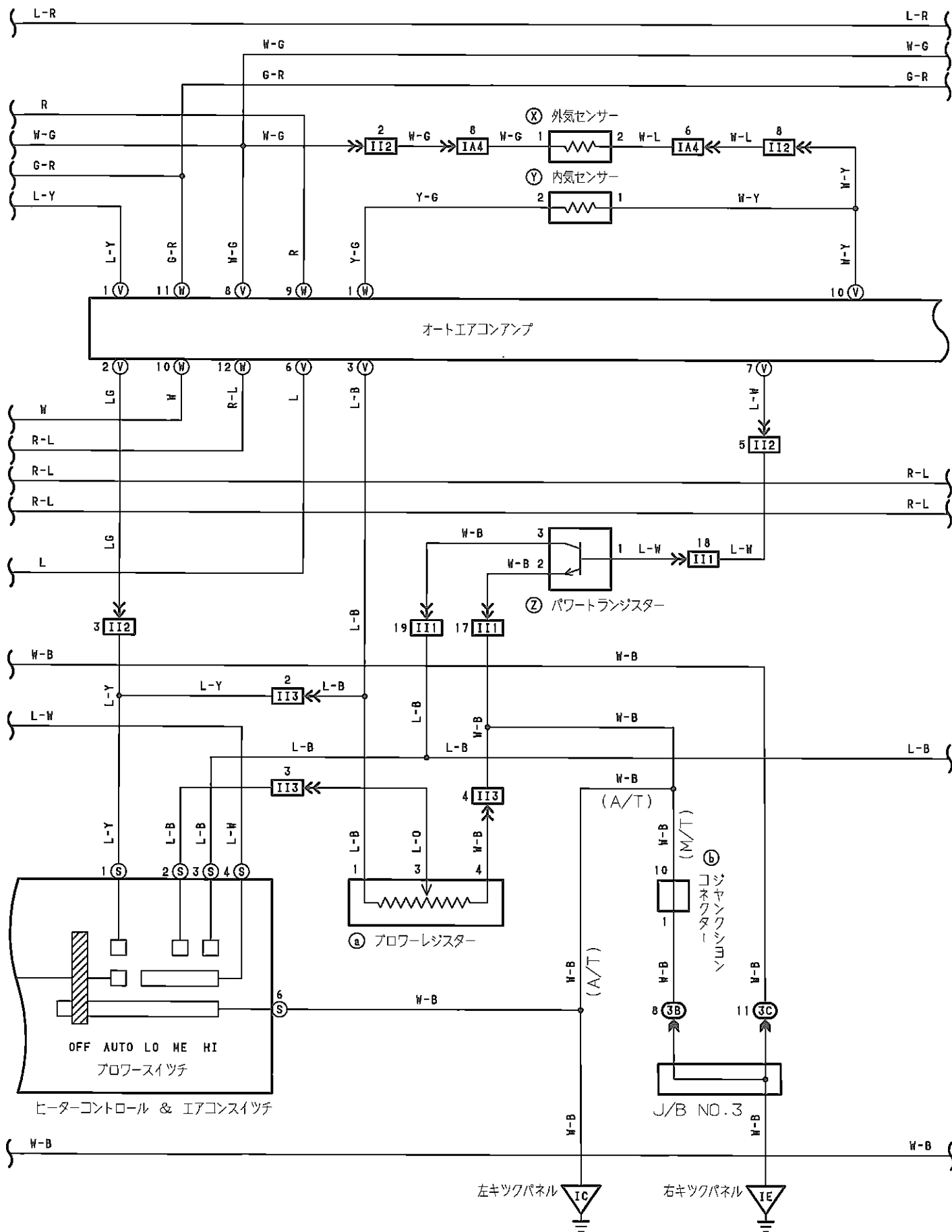

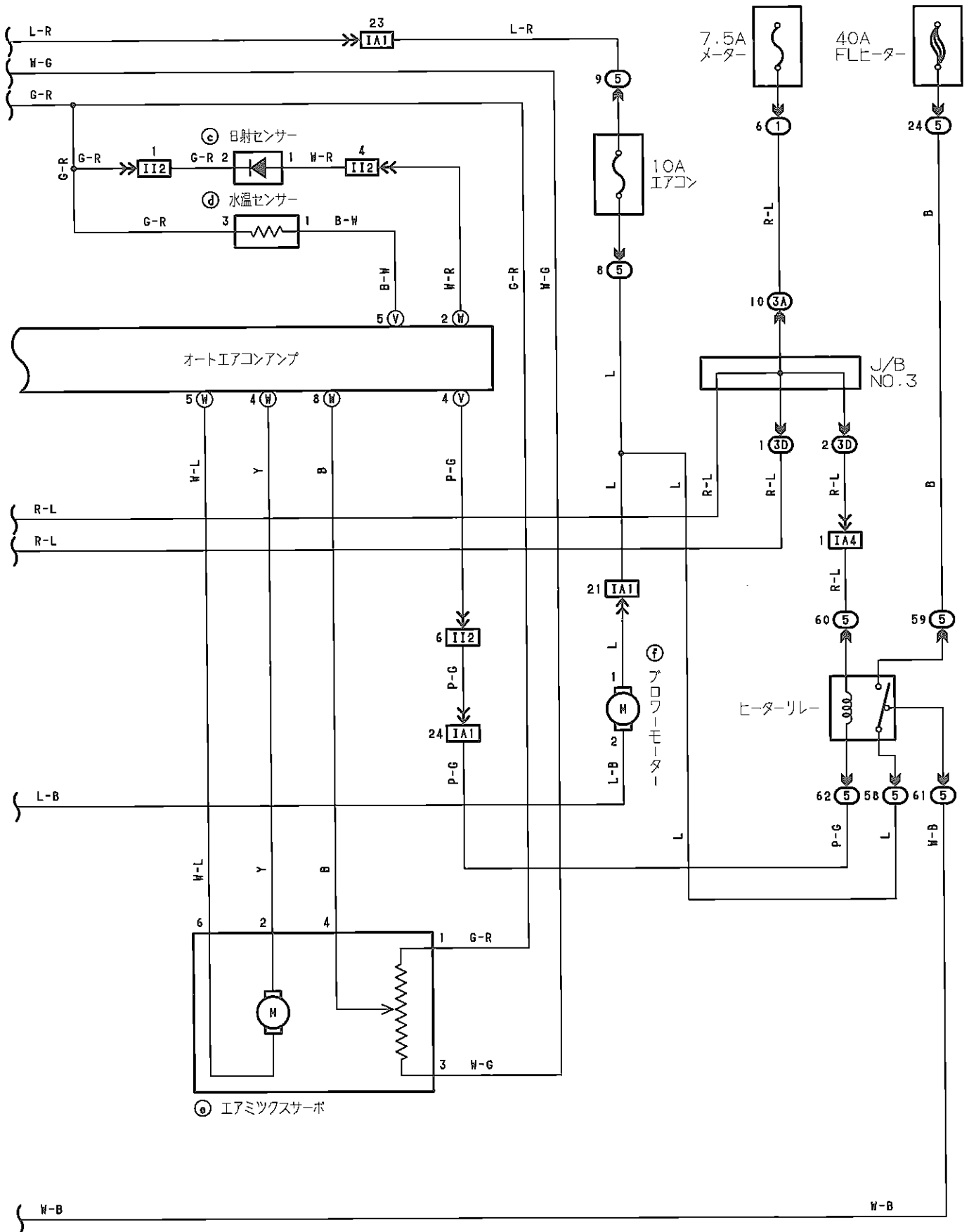



ラジエーターファン(エアコン付き) & オートエアコンデিশヨナー

Ⓐ 黒色

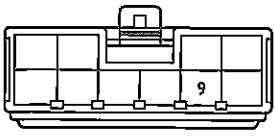

Ⓑ Y

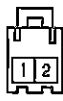

Ⓒ Ⓓ 灰色

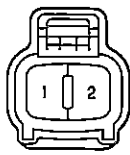

Ⓔ Ⓕ



Ⓕ

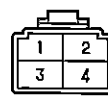

Ⓖ 灰色



Ⓕ

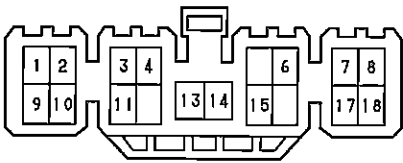

Ⓖ 濃灰色

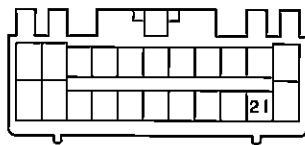

Ⓖ 黒色

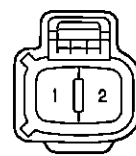

Ⓖ 黒色



Ⓖ X 黒色



Ⓖ

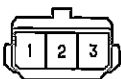

Ⓖ

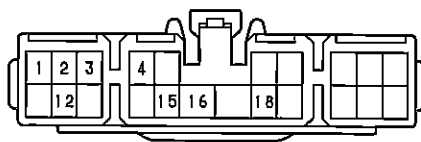

Ⓖ



Ⓖ

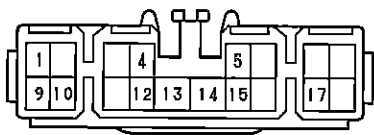

Ⓖ

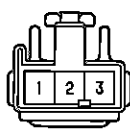

Ⓖ

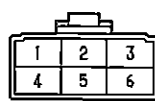

Ⓖ

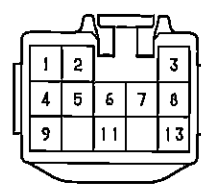

Ⓖ



Ⓖ

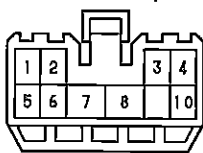

Ⓖ

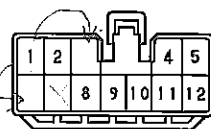

Ⓖ



Ⓖ 黒色



Ⓖ

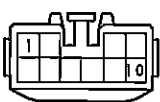

Ⓖ



Ⓖ



Ⓖ

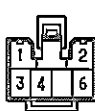

Ⓖ 黒色



3A

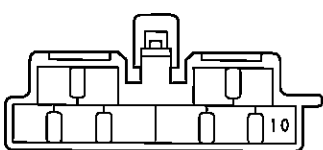

3B

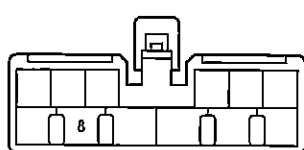

3C

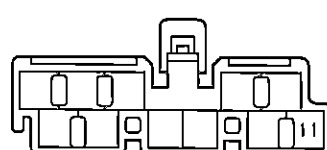

3D

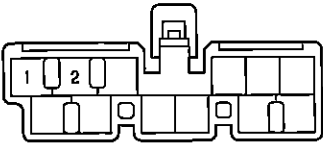

IA1

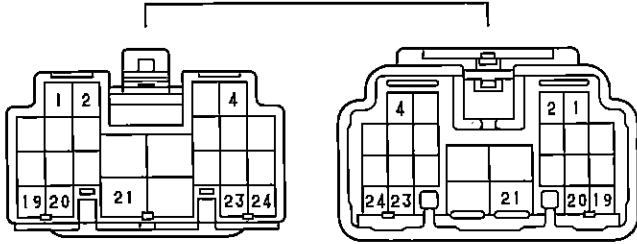

IA4

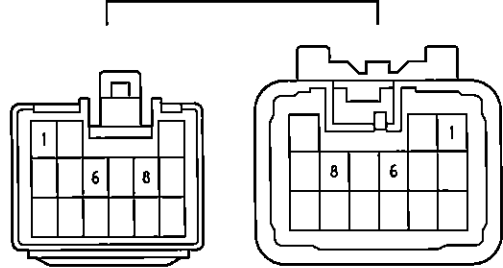

IC2

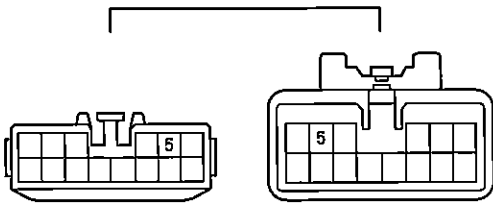

IE1 EG2

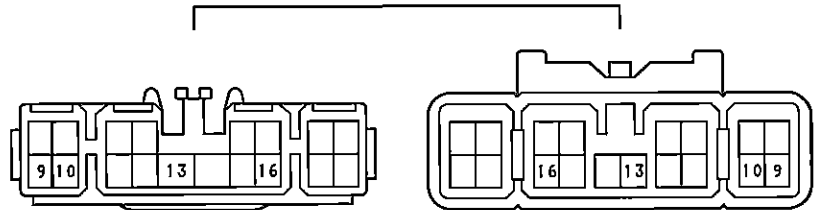

IE2

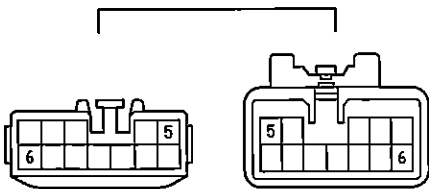

IE3

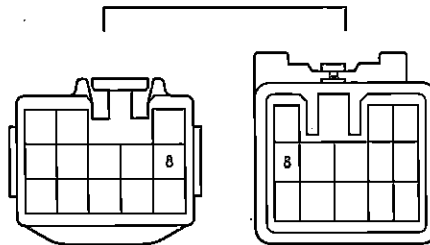

II1

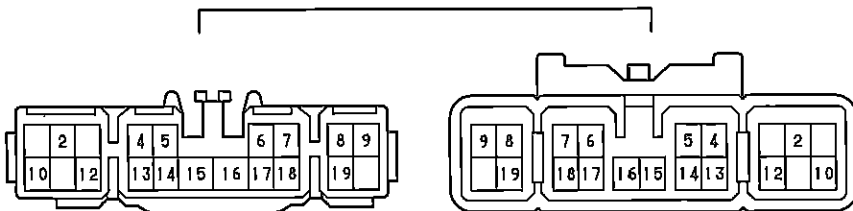

II2

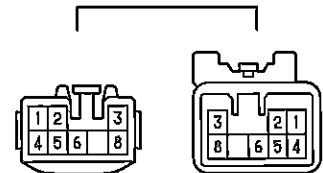

II3 黑色

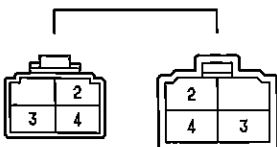

ヒーター(エアコンなし)

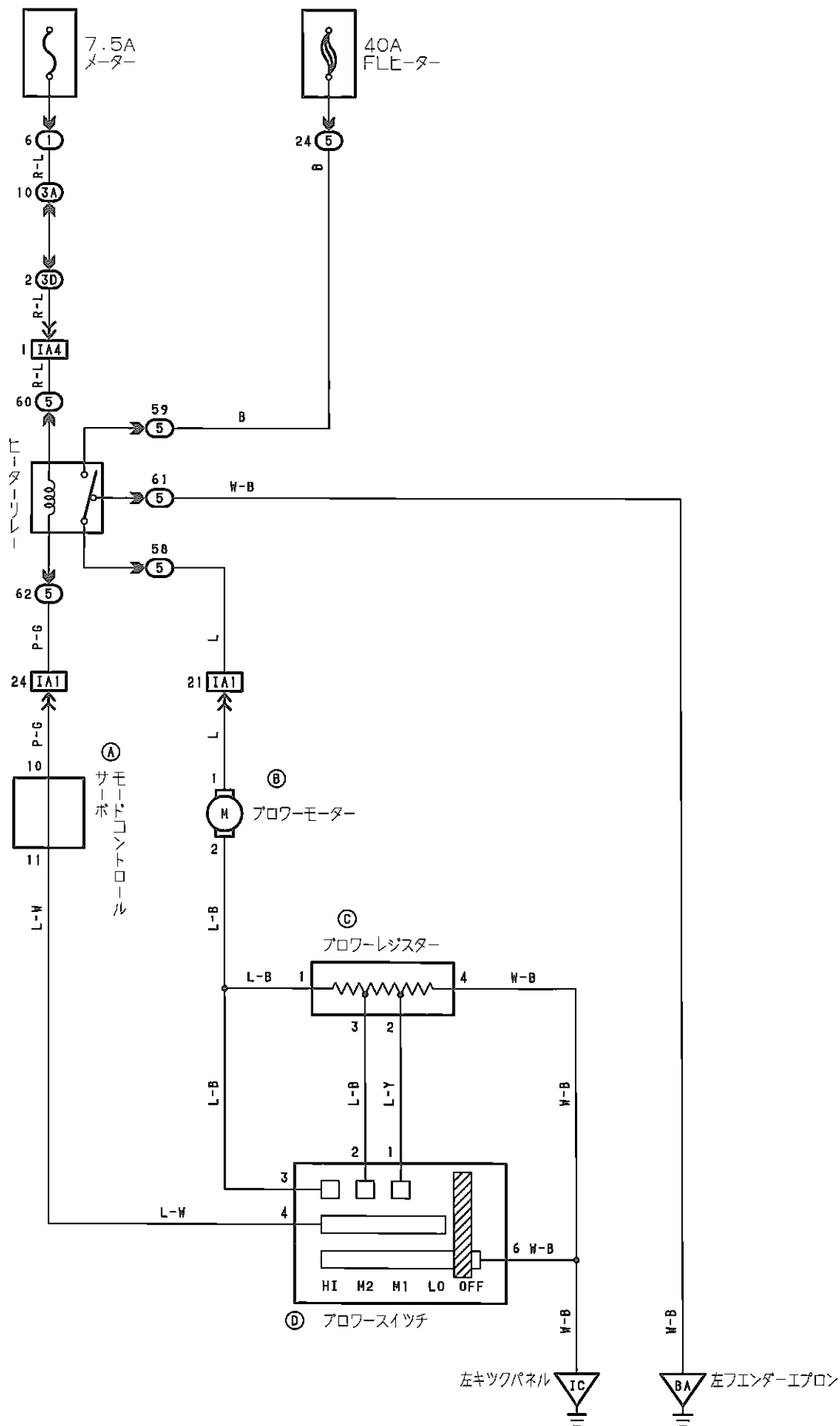

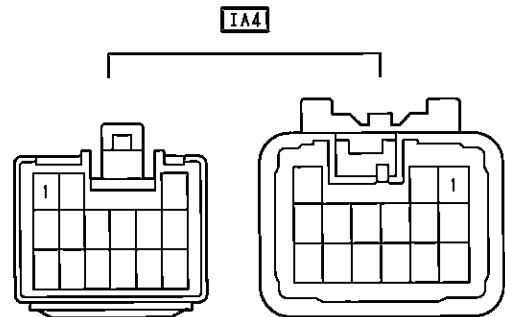
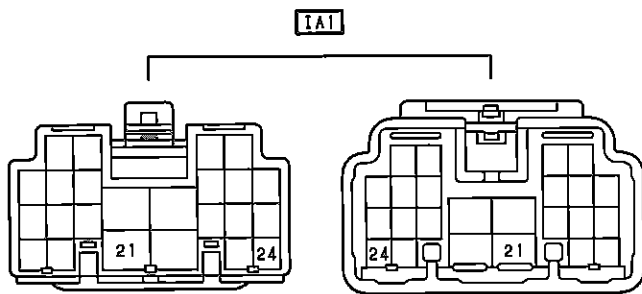
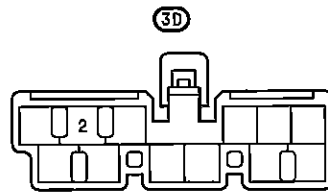
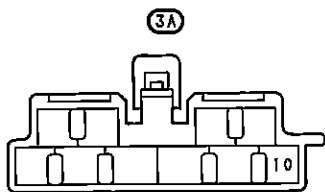
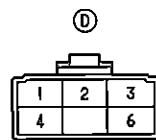
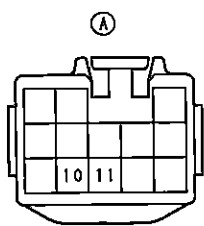

アースポイント

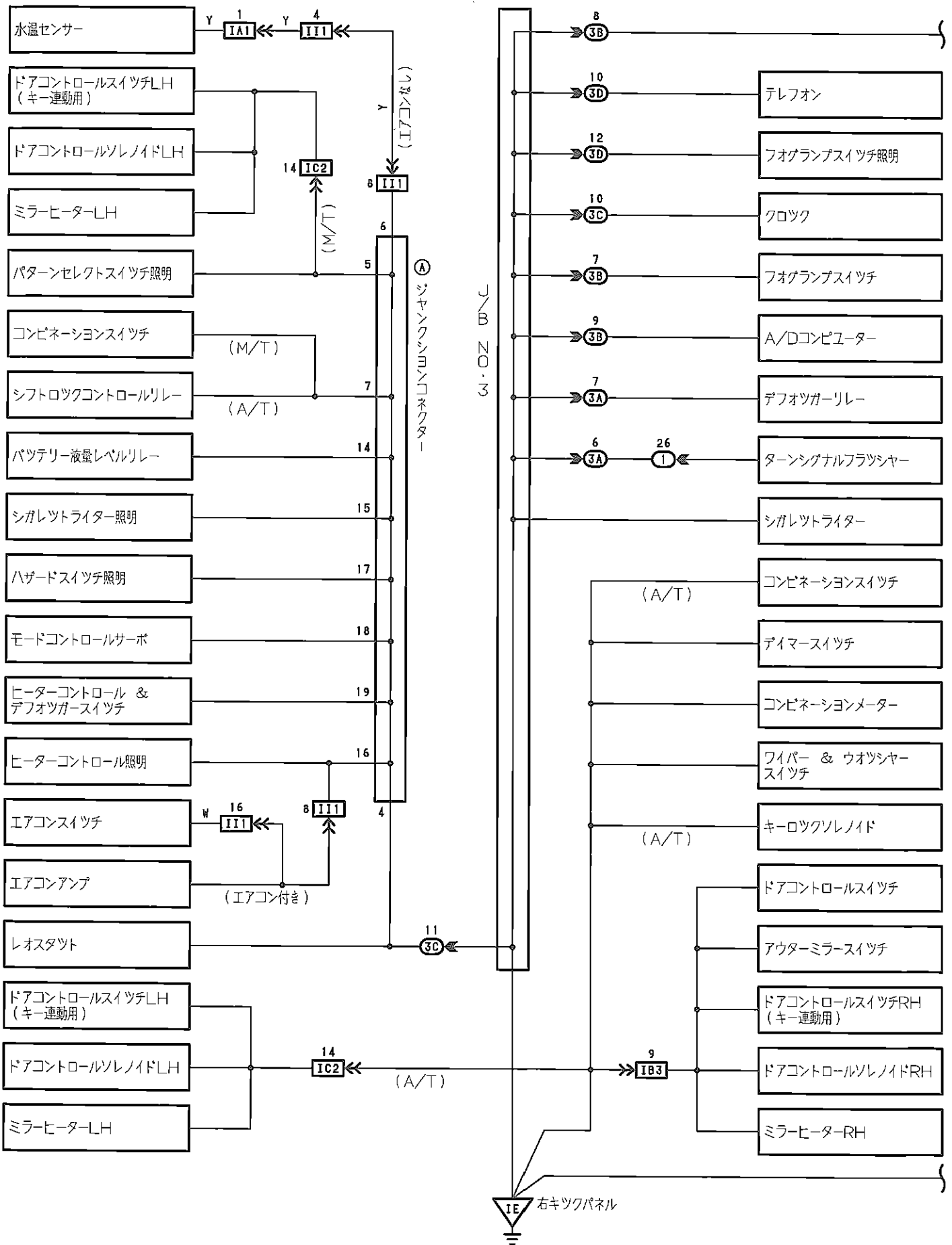

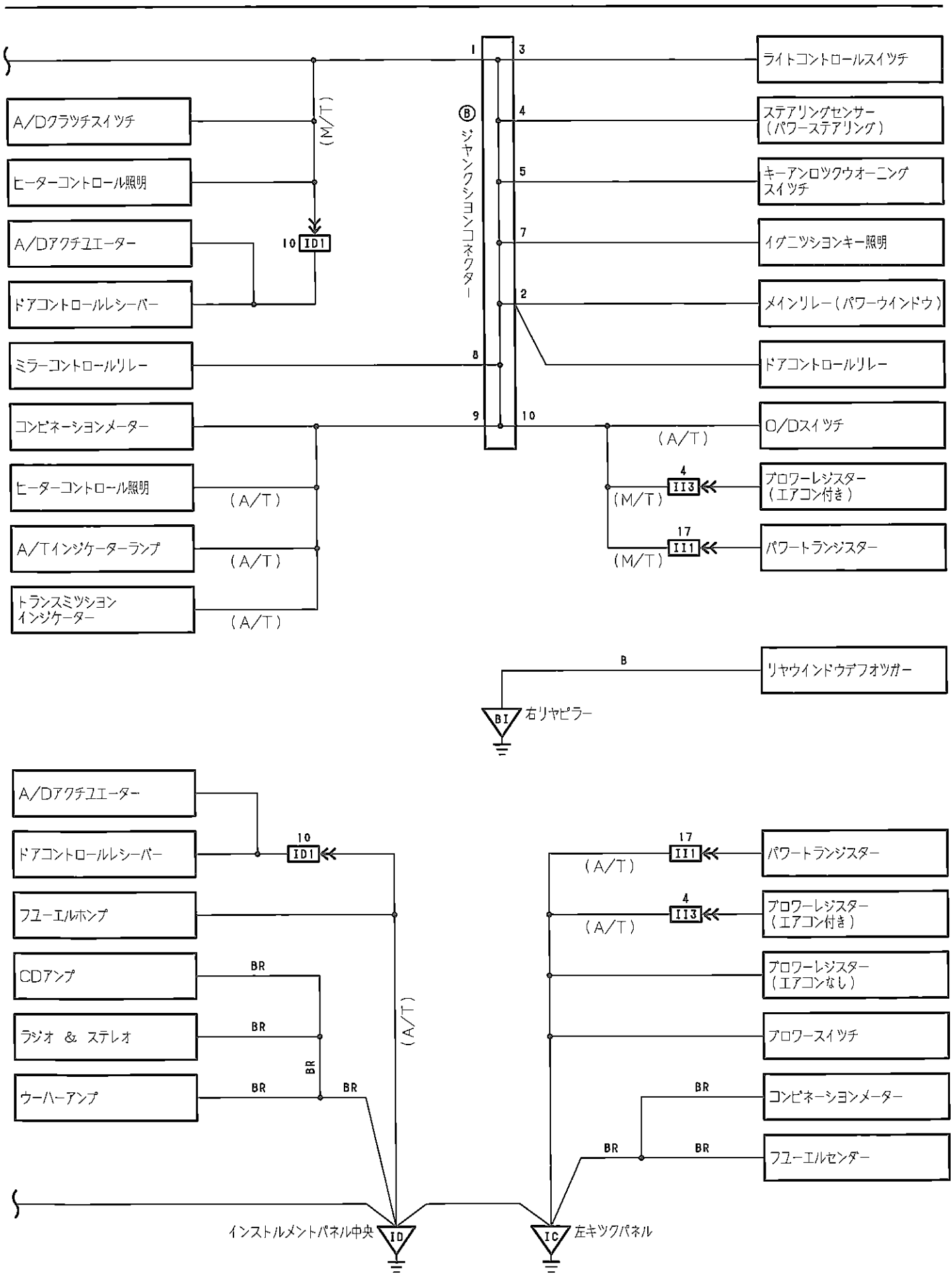

≡ アースポイント

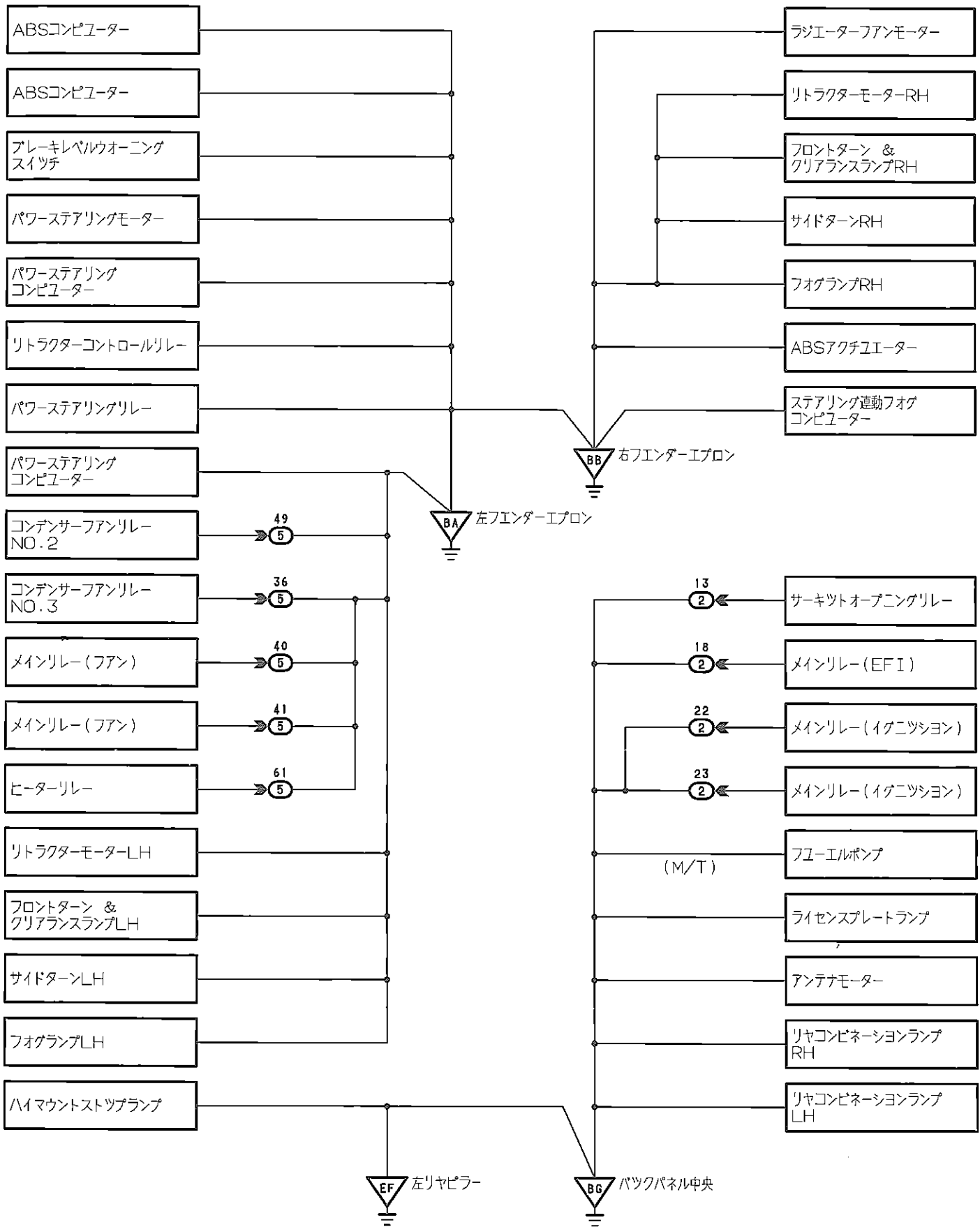

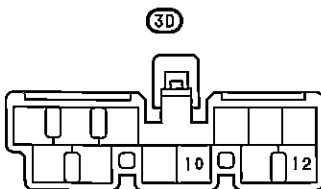
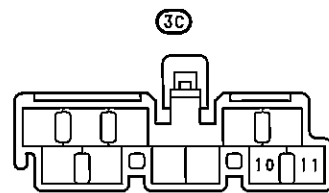
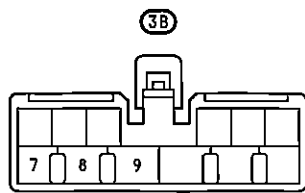
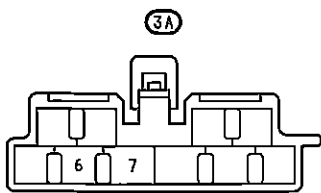
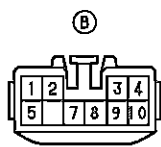
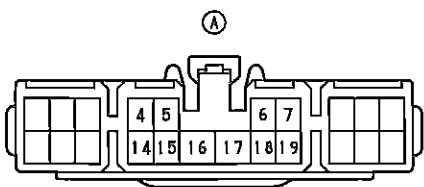
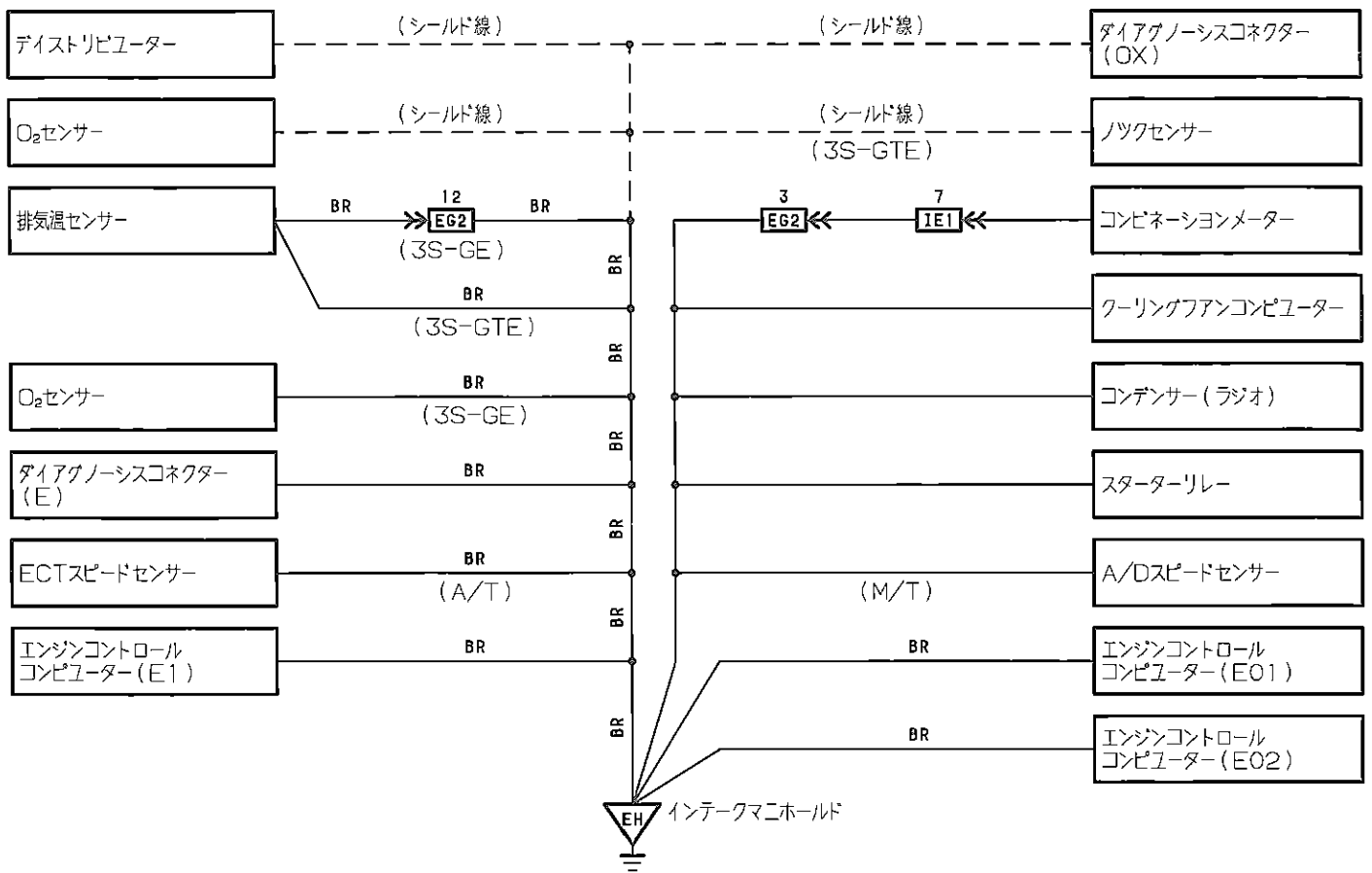

≡ アースポイント

IA1

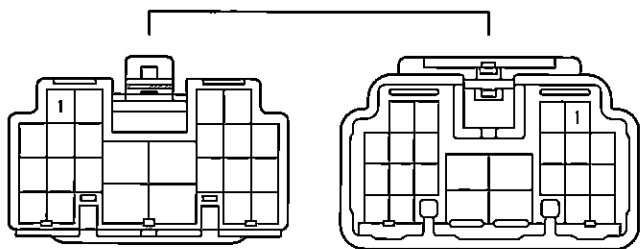

IB3

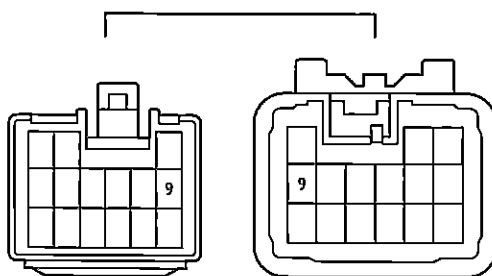

IC2

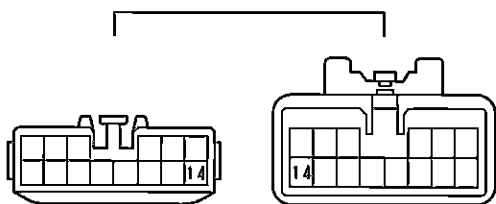

ID1 IE1 EG2

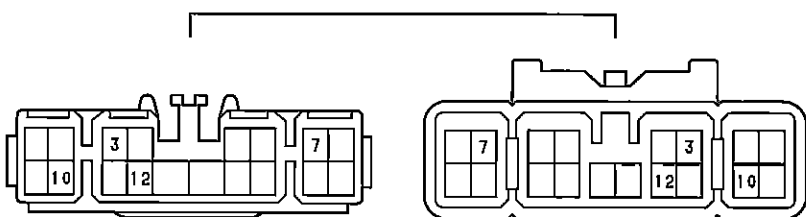

III

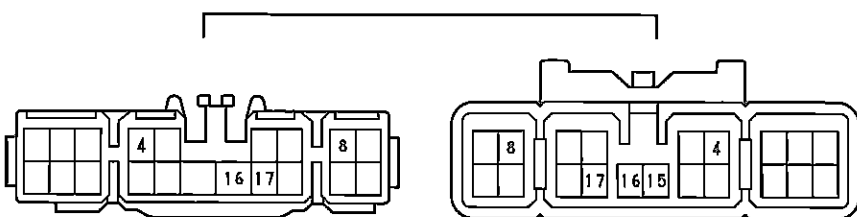

II3 黒色

